

JUNE 2021

EUROPEAN HYDROGEN BACKBONE

Analysing future demand, supply, and transport of hydrogen

A cooperation with



GAS FOR CLIMATE
A path to 2050

Creos, DESFA, Elering, Enagás, Energinet, Eustream, FGSZ, Fluxys Belgium, Gas Connect Austria, Gasgrid Finland, Gasunie, Gaz-System, Gas Networks Ireland, GRTgaz, National Grid, NET4GAS, Nordion Energi, OGE, ONTRAS, Plinovodi, Snam, TAG, Teréga

Imprint

Supported by:
Guidehouse



Authors:
Anthony Wang, Jaro Jens, David Mavins,
Marissa Moultak, Matthias Schimmel, Kees van
der Leun, Daan Peters, Maud Buseman

Date:
June 2021

Contact:
Guidehouse
Stadsplateau 15, 3521 AZ Utrecht
The Netherlands
+31 30 662 3300
guidehouse.com

Picture credits:
Title motif based on a map of ENTSOG
(see <https://transparency.entsog.eu/>)

Design:
Meike Naumann Visuelle Kommunikation

Table of contents

Unit conversions	4		
List of abbreviations and acronyms	4		
Executive summary	5		
1. Introduction	9		
2. Hydrogen Demand	11		
2.1. Industry	12		
2.1.1. Iron & steel	17		
2.1.2. Ammonia for fertilizers	20		
2.1.3. High value chemicals	23		
2.1.4. Fuel production	27		
2.1.5. Industrial process heat	29		
2.2. Transport	31		
2.2.1. Road transport	31		
2.2.2. Aviation	34		
2.2.3. Shipping	36		
2.2.4. Transport conclusions	37		
2.3. Power	38		
2.4. Buildings	42		
2.5. Conclusions on hydrogen demand	51		
3. Hydrogen Supply	53		
3.1. Introduction	54		
3.2. Green Hydrogen	54		
3.2.1. Renewable energy supply potential	55		
3.2.2. Green hydrogen supply potential	57		
3.2.3. Green hydrogen production costs	59		
3.2.4. Green hydrogen and electrolysis in national hydrogen strategies	62		
3.2.5. Summary	63		
3.3. Blue Hydrogen	64		
3.4. Imports of green and blue hydrogen	67		
		4. Hydrogen Transport Infrastructure	70
		4.1. Hydrogen Transport by Pipeline	70
		4.2. Hydrogen Transport by Ship	74
		4.3. Comparison of Hydrogen Transport Methods and Supply Routes	76
		4.4. Comparison of Electricity and Hydrogen Infrastructure	80
		4.4.1. Transport cost comparison between pipeline and power line	80
		4.4.2. Energy storage, system integration, and societal acceptance	82
		Appendix A. Hydrogen Demand – Methodology	85
		A.1. Industry	85
		A.2. Transport	88
		A.3. Power	91
		A.4. Buildings	94
		Appendix B. Hydrogen Supply – Methodology	97
		B.1. Green Hydrogen	97
		B.2. Blue Hydrogen	106
		Appendix C. Hydrogen Transport Infrastructure – Methodology	107
		C.1. Hydrogen Transport by Pipeline	107
		C.2. Hydrogen Transport by Ship	109
		C.3. Comparison of Hydrogen Transport Methods and Supply Routes	111
		C.4. Comparison of Electricity and Hydrogen Infrastructure	112

Unit conversions

1 kg H₂ = 11.1 m³ H₂ (0 °C, 1 bar)

1 kg H₂ = 33.3 kWh (LHV)

1 kg H₂ = 120.1 MJ (LHV)

List of abbreviations and acronyms

ASHP	Air-Source Heat Pump	kg	Kilogramme
ATR	Auto Thermal Reformer	km	Kilometre
BECCS	Bio Energy Carbon Capture and Sequestration	kW	Kilowatt
BF	Blast Furnace	kWh	Kilowatt-Hour
BNEF	BloombergNEF	LH₂	Liquid Hydrogen
BOF	Basic Oxygen Furnace	LHV	Lower Heating Value
CAPEX	Capital Cost	LNG	Liquefied Natural Gas
CCS	Carbon Capture and Storage	LOHC	Liquid Organic Hydrogen Carriers
CCU	Carbon Capture and Utilisation	MENA	Middle East and North Africa
CCUS	Carbon Capture, Utilisation and Storage	MGO	Marine Gasoil
CNG	Compressed Natural Gas	MtO	Methanol to Olefins
CO₂	Carbon Dioxide	MVA	Megavolt-Ampere
DAC	Direct Air Capture	MW	Megawatt
DR	Direct Reduction	MWh	Megawatt-Hour
DRI	Direct Reduced Iron	NECP	National Energy and Climate Plan
DSO	Distribution System Operator	NIMBY	Not in My Backyard
Scrap-EAF	Scrap-Electric Arc Furnace	NO_x	Nitrogen Oxides
EC	European Commission	NUTS	Nomenclature of Territorial Units
EHB	European Hydrogen Backbone	OPEX	Operating Costs
EU ETS	European Union Emissions Trading System	PCI	Pulverised coal injection
EUR	Euro	PV	Photovoltaic
FCHJU	Fuel Cells and Hydrogen Joint Undertakings	R&D	Research and Development
GHG	Greenhouse Gas	RES	Renewable Energy Source
GW	Gigawatt	SAF	Sustainable Aviation Fuel
HBI	Hot Briquetted Iron	SMR	Steam Methane Reforming
HP	Heat Pump	SO_x	Sulphur Oxides
HVAC	High Voltage Alternating Current	TSO	Transmission System Operator
HVC	High Value Chemicals	TWh	Terawatt-Hour
HVDC	High Voltage Direct Current	TYNDP	Ten-Year Network Development Plan
IEA	International Energy Agency	UK	United Kingdom
JRC	Joint Research Centre	VLSFO	Very Low Sulphur Fuel Oil



Executive summary

Hydrogen is crucial to Europe's transformation into a climate-neutral continent by mid-century. This study concludes that the European Union (EU) and UK could see a hydrogen demand of 2,300 TWh (2,150-2,750 TWh) by 2050. This corresponds to 20-25% of EU and UK final energy consumption by 2050. Achieving this future role of hydrogen depends on many factors including market frameworks, legislation, technology readiness and consumer choice.

Green and blue hydrogen are crucial for our industrial decarbonisation pathway. It is particularly relevant for chemicals (ammonia and high-value chemicals), iron and steel, and fuel production where hydrogen is primarily used as feedstock. Green and blue hydrogen replaces the current use of grey hydrogen in ammonia and fuel production and is a main input for the production of low-carbon fuels used in aviation or as feedstock for the production of high-value chemicals. Hydrogen-based steel making is considered the main decarbonisation option for primary steel making. About 1,200 TWh of annual hydrogen demand in industry can be expected, including just over 200 TWh for medium and high temperature industrial process heat.

Around 650 TWh of annual hydrogen demand can be expected to be required in dispatchable electricity production. The value of hydrogen over most other flexible power options is that it can be supplied and stored in large quantities at relatively cheaper investment costs, making it appealing for longer duration storage.

In transport, next to electrification and biofuels, there is a clear role for about 300 TWh per year of hydrogen as a fuel. Additional hydrogen will be needed to produce hydrogen-derived synthetic fuels in aviation.¹

Heating in buildings will be decarbonised using a range of technologies with significant regional variations. The hydrogen demand depends on renovation rates, the relative shares of biomethane and hydrogen, and the mix of heating technologies. This study assumes Europe-wide accelerated renovation rates and hybrid heating systems in existing homes with a gas connection and in 30% of district heating. Such hybrid systems use electricity (in a heat pump) and renewable or low-carbon gas. This approach reduces energy system costs, enabling lower cost to consumers and faster emission reduction. As the hybrid heating systems mainly use gas as peak energy supply, gas demand is lower than in gas-only solutions like hydrogen boilers and fuel cells considered in other studies. Under this study's assumptions, annual renewable and low-carbon gas demand in buildings will be around 600 TWh in 2050. All of this could be hydrogen, yet assuming a scale-up of biomethane as in previous Gas for Climate studies, annual hydrogen demand would be around 150 TWh.



Domestic European green and blue hydrogen supply potential is vast and exceeds what would be needed to meet projected European hydrogen demand in all sectors

Domestic green hydrogen supply potential in the EU and UK from dedicated renewables is estimated to be 450 TWh in 2030, 2,100 TWh in 2040, and 4,000 TWh in 2050. This potential already takes into account the growing need for renewable electricity for direct consumption, land availability, environmental considerations and installation rates. Realising this potential will likely require a rapid, vast expansion of wind and solar capacity, beyond what is needed for direct electricity demand and corresponding to cumulative installed capacities of 1,900 GW in 2030, 3,200 GW in 2040, and 4,500 GW in 2050. The 2030 installed capacity figure represents a more than doubling of current cumulative National

¹ This additional hydrogen demand, mainly for synthetic fuels, is included in the industry demand segment.

Energy and Climate Plan targets.

From 2040, green hydrogen supply potential in Europe can be sufficient to meet projected European hydrogen demand in all sectors at lower cost levels compared to grey hydrogen and other fossil alternatives plus the CO₂ price. By 2050, almost all of the potential 4,000 TWh of green hydrogen can be produced for less than 2.0 €/kg, of which up to 2,500 TWh can be produced below 1.5 €/kg and around 600 TWh produced at 1.0 €/kg or less. Supplying the entire projected 2,150-2,750 TWh hydrogen demand in 2050 would require around 2,900-3,800 TWh of dedicated renewable electricity.

However, producing such quantities of green hydrogen within the EU and UK is subject to public acceptance of an accelerated expansion of renewable installed capacity even beyond currently planned expansion.

In addition to green hydrogen, Europe also has a large potential to produce blue hydrogen. Supply is virtually unlimited as natural gas supply and CO₂-storage potential exceed the total foreseen hydrogen demand. Blue hydrogen production costs are expected to be 1.4-2.0 €/kg at moderate natural gas and CO₂-prices², but could rise up to 1.6-2.3 €/kg during the 2030s and 2040s when CO₂-prices further increase. Natural gas producing countries could benefit from lower natural gas costs to produce blue hydrogen at 1 €/kg. Blue hydrogen can quickly drive emission reductions and accelerate the pace of the transition, especially in the market's ramp-up phase (2030), when green hydrogen supply potential from dedicated renewables alone will be insufficient to meet local and regional demand in absence of a fully interconnected European hydrogen backbone. Although EU and UK greenfield and brownfield blue hydrogen supply potential is almost unlimited, projects announced to date add up to 230 TWh by 2030 and 380 TWh by 2035 and onwards – with 70% of announced project volumes stemming from the UK and the Netherlands.

Beyond 2030, deployment of new blue hydrogen projects will face increasing competition from green hydrogen (domestic and import), as this becomes more widely available at lower costs. However, there will still be a role for (by then) existing blue hydrogen projects—which have a lifespan of 25 years—to continue producing as the marginal supply option and to contribute to system integration and balancing of variable green hydrogen through firm, baseload hydrogen production.



A European Hydrogen Backbone is essential to ensure the creation of an EU hydrogen market, to reconcile substantial regional differences in hydrogen supply and demand, and to connect Europe to neighbouring regions with abundant and cost-competitive hydrogen supply potential.

Repurposed existing gas infrastructure plays a crucial role in connecting hydrogen supply and demand locations and in providing security of demand for supply project investors, as well as security of supply and competition for future offtakers.

By 2030, even under modest flows, countries with low domestic hydrogen supply potential compared to their expected demand (like Germany and Belgium) will need to import hydrogen to meet national requirements. This import need creates a clear role for the emerging hydrogen backbone. These regional differences in hydrogen

2 Assuming natural gas prices of 20€/MWh and CO₂ transport and storage costs of 50 €/tCO₂.

supply and demand will increase over time as the market develops.

Hydrogen pipelines are the most cost-efficient option for long-distance, high-volume transport at €0.11-0.21/kg (€3.3-6.3/MWh) per 1,000 km, outcompeting transport by ship for all reasonable distances within Europe and neighbouring regions. All shipping methods – ammonia, LOHC, and LH₂ – have high upfront costs, related to conversion and reconversion installations and in the case of LOHC the carrier chemical costs. Ship-transport is three to five times more expensive compared to pipeline transport when looking at north-Africa and Saudi Arabia. For imports from Australia pipelines are not an option and ship-transport costs are estimated to be around 1.0 €/kg of H₂.

Hydrogen infrastructure and electricity networks each possess their complementary strengths when it comes to long-distance transport of decarbonised energy carriers. The cost-optimal energy transport option depends on factors such as the desired end-use energy carrier, availability and cost of storage, renewable energy supply characteristics, and network topology. For high-volume transport of energy when the desired end-product is hydrogen, pipelines – both newly built and repurposed ones – are 2 to 4 times more cost-effective than overhead power lines delivering the same amount of energy. This comparison excludes storage costs for electricity and hydrogen. In addition, the consideration between gas and electricity transport is not only an economic question but also one of societal acceptance. A 48-inch underground hydrogen pipeline (the size as it is used today for natural gas) can transport the same amount of energy as 7 overhead transmission lines.



In addition to domestic EU and UK supply, abundant natural resources and physical proximity drive the favourable economics of pipeline imports from neighbouring regions (such as North Africa and Ukraine), making these regions attractive partners for future hydrogen trade.

Neighbouring regions have significant hydrogen supply potential at competitive costs, which can become available to consumers through the European Hydrogen Backbone. By 2040, with expected levelised costs of green hydrogen production of 1.0-2.0 €/kg for onshore wind and solar PV, producers in Ukraine and North Africa could benefit from a mature backbone at levelised transport costs of 0.2-0.5 €/kg. This makes green hydrogen imports of 1.5-2.5 €/kg an attractive complement to domestic supply options in parts of Europe – especially considering more challenging conditions around land availability and public acceptance of renewables in European countries.

For regions with abundant natural resources such as Ukraine, North Africa, Norway, and potentially the Middle East and Russia, some of which are labelled as ‘priority partners’ in the EU Hydrogen Strategy, hydrogen imports by pipeline seem the most cost-effective option. Imports from further away could take place by ship, which will have higher costs, mainly due to (re)conversion losses. Given their higher costs, these imports are better suited to decarbonise sectors where they can be used directly as a fuel or feedstock, without reconversion. It should be ensured that imported hydrogen is produced sustainably with high greenhouse gas savings.

FIGURE 1

Overview of hydrogen supply potential and hydrogen demand in 2050

At a glance: European hydrogen Backbone

Analysing future demand, supply, and transport of hydrogen

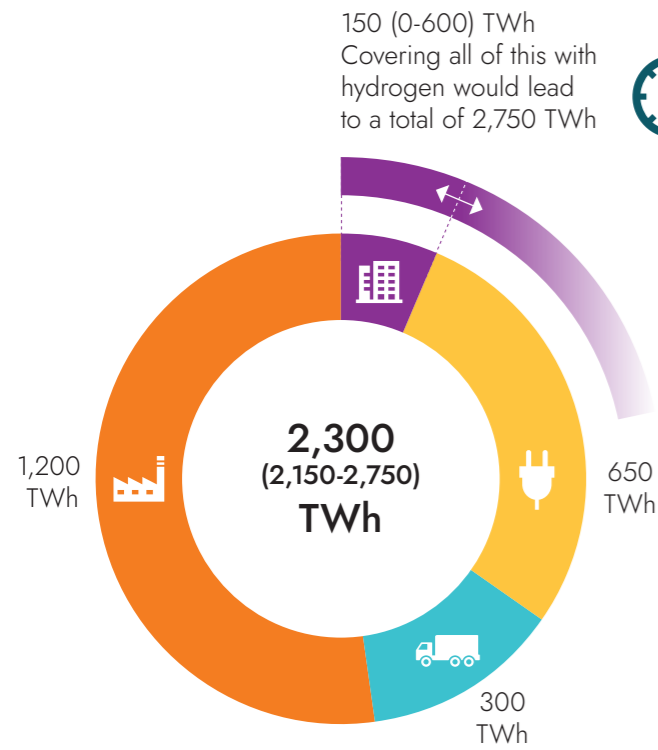

Hydrogen will be crucial to ensure that Europe becomes a climate-neutral continent

- The EU and UK could see a hydrogen demand of around 2,300 TWh by 2050:
- About 1,200 TWh of hydrogen in **industry** can be expected, including just over 200 TWh of high temperature industrial heat.
 - Some 650 TWh of hydrogen in **dispatchable electricity production**.
 - Alongside other options such as electrification and biofuels, some 300 TWh of hydrogen and hydrogen-derived carriers can help to decarbonise **transport**.
 - Under an accelerated renovation scenario, gas demand in the **building stock** will be around 600 TWh. This demand could be met with biomethane and hydrogen. Under the assumptions of this study around 150 TWh of hydrogen would be used in buildings.



Domestic European hydrogen supply potential exceeds what would be needed to meet projected demand

- EU and UK **green hydrogen** supply potential from dedicated renewables—considering the needs of the electricity market, land availability, environmental regulations, and installation rates—is estimated to be 450 TWh in 2030, 2,100 TWh in 2040, and 4,000 TWh in 2050.
- Europe also can also produce large quantities of **blue hydrogen**, which can enable a quick start to the use of hydrogen to drive emission reductions and accelerate the pace of the transition

A European Hydrogen Backbone will be essential to facilitate the creation of a European hydrogen market



- **Repurposed existing gas infrastructure plays a crucial role in connecting hydrogen supply and demand locations**
- **Hydrogen pipeline infrastructure is the most cost-efficient option for long-distance, high-volume transport** at €0.11-0.21/kg/1,000 km, outcompeting transport by ship for all reasonable distances within Europe and neighbouring regions.
- **To transport volumes of energy corresponding to a single 48-inch hydrogen pipeline (up to 16.9 GW)** through power transmission would require the equivalent of 7 overhead transmission lines.
- In addition to domestic EU+UK supply, **favourable economics of pipeline transport** allow cost-competitive imports from regions such as North Africa, Norway and Ukraine.

- Green hydrogen supply potential from dedicated renewables
- Blue hydrogen supply potential
- Hydrogen demand
- Difference between supply potential and demand
- * Additional blue hydrogen supply potential available

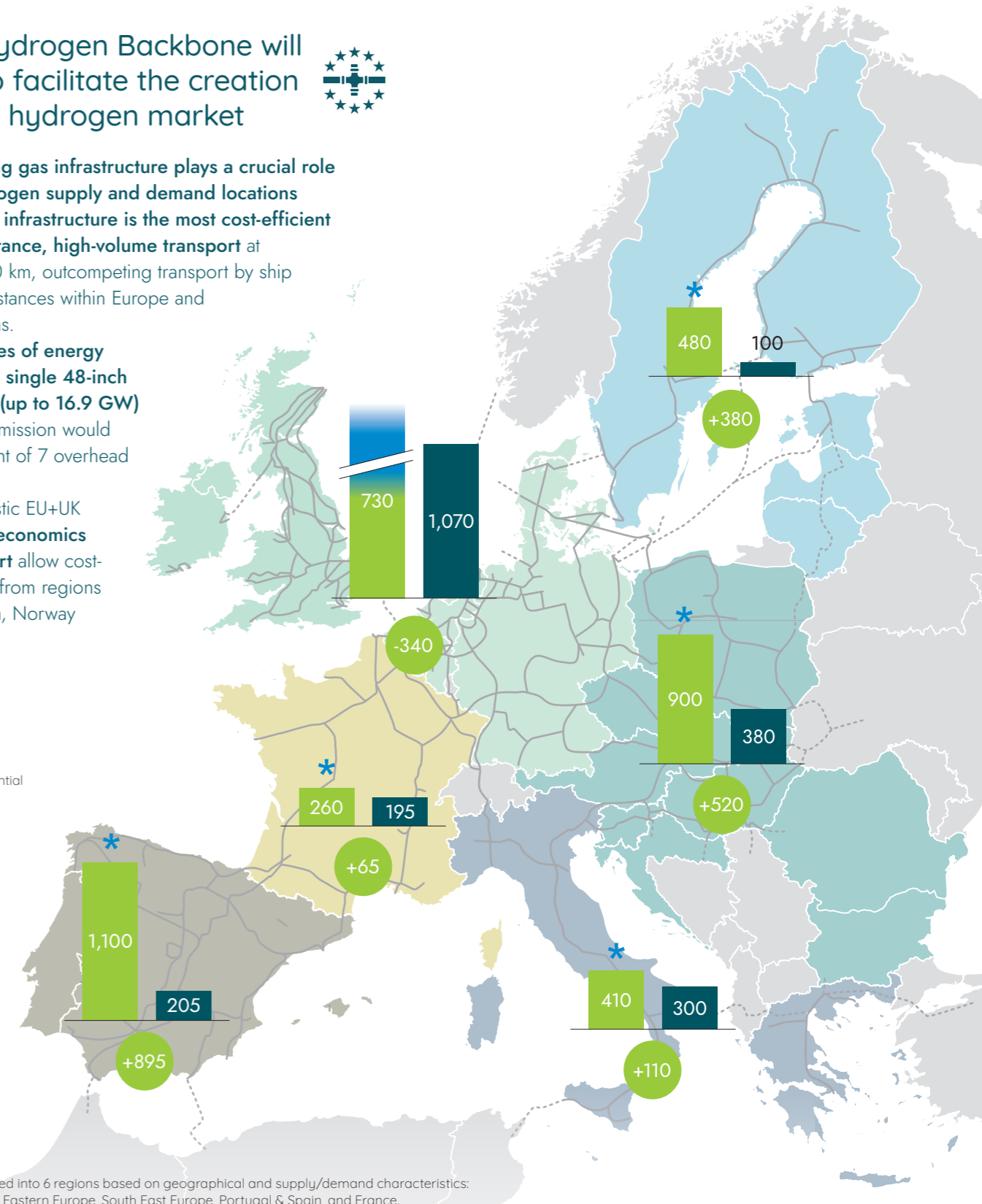

Figures in infographic are expressed in terawatt-hour per year in 2050. Note that as a result of the chosen methodology, demand figures represented in this Infographic may differ from other (national) decarbonisation scenarios. Source: Guidehouse analysis.

EU countries and UK are grouped into 6 regions based on geographical and supply/demand characteristics: North Sea, Baltic Sea, Central & Eastern Europe, South East Europe, Portugal & Spain, and France.

1. Introduction

The European Hydrogen Backbone (EHB) initiative is a group of European gas Transmission System Operators (TSOs) that has published a proposal for a dedicated European hydrogen pipeline infrastructure, to a large extent based on repurposed natural gas pipelines in order to connect hydrogen demand clusters and regions with high renewable energy potentials in a cost-efficient way. The initiative published an initial vision paper in July 2020, with maps covering nine EU Member States plus Switzerland, home to the eleven TSOs participating at that time. Since then, the EHB initiative has grown to 23 European gas TSOs with gas networks covering 19 EU Member States plus the United Kingdom and Switzerland. An updated report containing a geographically extended vision for a dedicated hydrogen infrastructure stretching across 21 European countries was presented in April 2021.³

This report presents the analyses, assumptions, and insights with regards to the future European hydrogen market—in terms of demand, supply, and infrastructure—to support the vision of the EHB initiative. It complements the publication of the extended European Hydrogen Backbone maps and explores the role of the European Hydrogen Backbone in facilitating the creation of a liquid, competitive hydrogen market in Europe with access to a vast market for potential supply developers and security of supply and freedom of choice by future offtakers.

This study explores the future role of green and blue hydrogen in enabling Europe to become a climate-neutral continent. In Europe, most hydrogen today is produced from natural gas in steam methane reforming without Carbon Capture and Storage (CCS); this type of hydrogen is called grey hydrogen. Adding CCS to grey hydrogen production, either by steam methane reforming or autothermal reforming (which allows for higher CO₂ capture rates), results in blue hydrogen. Another form of blue hydrogen is turquoise hydrogen, from natural gas in a relatively new, high temperature process called pyrolysis, which produces hydrogen with solid carbon as by product, instead of carbon dioxide.

Hydrogen can also be produced using electricity, by electrolysis of water, with pure oxygen as by-product. When nuclear electricity is used this results in yellow (sometimes also called pink or red) hydrogen. Using renewable electricity, such as wind and solar power, produces green hydrogen. This study focuses on green and blue hydrogen, the two most prominent forms.

Starting with a thorough own assessment of the demand for hydrogen, Chapter 2 presents an overview of the latest insights regarding hydrogen consumption in the industry, transport, power, and buildings sectors whilst also drawing on insights from prior studies commissioned by the Gas for Climate consortium, most notably 'Gas for Climate. The optimal role for gas in a net zero emissions energy system', published in 2019 and 'Gas decarbonisation pathways 2020-2050', published in 2020⁴. Hydrogen demand projections per sector are estimated at NUTS 2 and country-level and aggregated to EU and UK wide level. This is carried out through a combination of bottom-up, geography- and sector-specific analyses, alongside top-down estimations whereby homogeneous assumptions are applied across the analysed countries.

Note: As a result of the chosen methodology and assumptions, demand figures represented in this report may differ from other (national) decarbonisation scenarios. In each of the relevant demand sub-chapters (industry, transport, power, and buildings), we identify key input assumptions—which for the sake of the analysis have been homogeneously applied across the analysed countries—that could have a substantial impact on hydrogen volumes in individual countries, and how differences in these assumptions explain potential discrepancies between projections in other scenarios.

³ <https://gasforclimate2050.eu/ehb/>

⁴ <https://gasforclimate2050.eu/publications/>

Adding to the understanding of where major volumes of hydrogen will be needed, Chapter 3 investigates where this hydrogen can come from. More specifically, the question is how much hydrogen can be produced, at what cost, where – considering both green and blue hydrogen production technologies and regions. Finally, Chapter 4 compares the different methods of connecting these hydrogen sources and sinks. This Chapter builds on the pipeline transport cost analysis previously conducted by TSOs for the April 2021 vision paper⁵ and adds a quantitative assessment of hydrogen transport by ship, as well as a qualitative discussion about the role of hydrogen infrastructure in complementing the power system to integrate renewables.

Although the EHB initiative recognises the importance of hydrogen storage and the benefits it provides in the context of renewable energy integration, security of supply, and connectivity and costs of the wider system, this paper does not analyse hydrogen storage in a quantitative manner. Similarly, modelling of hydrogen and natural gas flows is out of scope in the present report. Nonetheless, the supply, demand, topology, and infrastructure cost figures presented in this and previous EHB publications can serve as starting points for such a modelling study.

5 <https://gasforclimate2050.eu/ehb/>

2. Hydrogen Demand

Industry

- Green and blue hydrogen are crucial for our industrial decarbonisation pathway. This is particularly relevant for iron & steel, ammonia, and fuels (including high value chemicals HVC) productions where hydrogen is primarily used as feedstock. Green and blue hydrogen demand in these sectors can be expected to increase to 238 TWh in 2030, 692 TWh in 2040 and 983 TWh in 2050.
- An additional demand could come from medium- and high-temperature industrial heat processes where hydrogen can partially substitute the current use of natural gas leading to at least 56 TWh in 2030, 165 TWh in 2040 and 217 TWh of demand in 2050.
- In comparison to the 2019 Gas for Climate study, we see an increased hydrogen demand in the steel sector and for fuel production, while biomass and recycling reduce hydrogen demand in parts of the chemical sector.

Transport

- In transport, next to electrification and biofuels, there is a clear role for about 300 TWh per year of hydrogen as a fuel. Additional hydrogen will be needed to produce synthetic fuels in aviation⁶. In 2050, hydrogen is forecasted to power 55% of trucks, 25% of buses, and 10% of airplanes. The demand for direct hydrogen in the transport sector in 2050 can be expected to be 285 TWh, with 68 TWh in aviation and 217 TWh in heavy road transport. Direct hydrogen is forecasted to account for 12% of total transport energy demand in 2050.

Power

- The value of hydrogen over most other flexible power options is that it can be supplied and stored in large quantities at relatively cheaper investment costs, making it particularly appealing for long-duration storage. Hydrogen can cost-effectively integrate and provide resilience to the highly electrified net-zero energy system (and economy) of the future.
- Hydrogen demand in the power sector is estimated to be 12 TWh in 2030, 301 TWh in 2040, and 626 TWh in 2050, accounting for 1%, 3%, and 7% of total EU and UK electricity demand in 2030, 2040, and 2050 respectively.
- Hydrogen generated electricity is forecast to comprise up to 17% of the electricity generation per country, with Poland, Ireland, Italy, Germany, and Belgium expected to have the highest shares of hydrogen generated electricity in 2050.
- Countries with high shares of gas-powered electricity generation (e.g. Belgium, Germany, Ireland, Italy, Poland and the UK) are expected to have high shares of hydrogen demand. Gas-fired power plants can transition from natural gas to hydrogen, making use of existing infrastructure and reducing necessary investment costs for the decarbonisation of dispatchable generators.

⁶ Only direct hydrogen use in heavy road transport and aviation is included in the transport section. Hydrogen demand to produce fuels is included in the industry section of the report.

Buildings

- Heating in buildings will be decarbonised using a range of technologies with significant regional variations. The hydrogen demand depends on renovation rates, the relative shares of biomethane and hydrogen, and the mix of heating technologies.
- This study assumes Europe-wide accelerated renovation rates and hybrid heating systems in existing homes with a gas connection and in 30% of district heating. Such hybrid systems use electricity (in a heat pump) and renewable or low-carbon gas. This approach reduces energy system costs, enabling lower cost to consumers and faster emission reduction. As the hybrid heating systems mainly use gas as peak energy supply, gas demand is lower than in gas-only solutions like hydrogen boilers and fuel cells considered in other studies. Under this study's assumptions, annual renewable and low-carbon gas demand in buildings will be around 600 TWh in 2050. All of this could be hydrogen, yet assuming a scale-up of biomethane as in previous Gas for Climate studies, annual hydrogen demand would be around 150 TWh.

“European industry needs a liquid, pan-European, competitive, secure, hydrogen market by 2030 to ensure its decarbonisation and competitiveness globally - this requires clear market signals such as the availability of a pan-European hydrogen backbone. In Duisburg, we will already need around 20 TWh/year of hydrogen by 2030.”

Dr. Markus Schöffel
Manager Sustainable Production
ThyssenKrupp Steel Europe AG

2.1. Industry

In line with the EU's climate target, Europe's industry should achieve net zero GHG emissions by 2050. While decarbonising industry is a significant challenge, there are multiple options for industry to achieve climate neutrality. Electricity consumed in industrial processes can be decarbonised by switching to renewable electricity generation. Processes that require heat can sometimes be electrified, however this becomes more challenging with increasing temperature requirements. To decarbonise these processes, post-combustion carbon capture and storage (CCS) or renewable and low-carbon fuels such as green and blue hydrogen or biomethane can be used. Biomethane in combination with CCS has the ability to create negative emissions, which is significant as almost all authoritative climate change scenarios show that the world needs substantial negative emissions to achieve net-zero GHG emissions and keep global temperature increase well below 2°C. If the process requires carbon-based feedstocks, biomass or synthetic feedstocks can replace the currently used fossil equivalent. Lastly, recycling and efficiency measures can further reduce the need for primary energy and feedstocks.

The analysis in this chapter describes the role for hydrogen in industry, in particular for ammonia, high-value chemicals, iron & steel and fuel production, in achieving net zero emissions. It follows the earlier study 'Gas for Climate. The optimal role for gas in a net zero emissions energy system'⁷, published in 2019, which analysed the use of hydrogen and biomethane in providing energy and feedstock to heavy industry. In the 2019 report, the focus was on the energy intensive industries ammonia, methanol (for high value chemical), iron & steel and cement and lime. Green or blue hydrogen was assumed to be the main decarbonisation option for ammonia and methanol while for steel it was CCS. For cement and lime, it was biomass and CCS. The present analysis forms an update of that earlier study, based on the latest insights on expected hydrogen demand in industrial sectors.

7 Gas for Climate. The optimal role for gas in a net zero emissions energy system' <https://gasforclimate2050.eu/wp-content/uploads/2020/03/Navigant-Gas-for-Climate-The-optimal-role-for-gas-in-a-net-zero-emissions-energy-system-March-2019.pdf>

Industrial processes are often highly energy intensive. As a result, the industrial sector accounts for around 20% of GHG emissions in the EU today, emitting 877 Mt of CO_{2eq} in 2017.⁸ Within the industry sector, the largest emitters are chemicals & petrochemicals (including fuel production), iron & steel and non-metallic minerals (e.g. cement). Much of the emissions come from the combustion of oil, natural gas, and solid fuels to generate heat (e.g. for steam or melting processes). Process emissions occur during the production of the product, however they come from chemical or physical processes other than combustion. For example, chemical crackers convert hydrocarbons into ethylene and propylene to be later converted into plastics. In addition, (primary) energy carriers are sometimes used as feedstocks for industrial processes. Feedstock emissions occur when the final product, e.g. fertilisers, is used.

As a result of energy efficiency improvements, a switch to low-carbon energy carriers and the displacement of some emission-intensive processes, the industry sector has seen a 35% GHG emissions reduction from 1990 to 2018⁹. However, to further accelerate emissions reduction in line with long-term decarbonisation goals, a rapid scale-up of renewable- and low-carbon energy carriers alongside implementation of breakthrough technologies is needed. Here, green and blue hydrogen can play a key role. Today, industry is the largest user of hydrogen, in particular in the chemical (e.g. ammonia) and petrochemical sectors. However, almost all of it is grey hydrogen leading to substantial GHG emissions. Green and blue hydrogen can replace the existing use of grey hydrogen and be a promising enabler of decarbonisation in other industry sectors. The steel industry could significantly reduce emissions by switching to hydrogen-based steelmaking. Hydrogen can also replace the existing use of fossil energy carriers in medium- and high-temperature processes (e.g. in glass, cement and pulp and paper) and replace fossil feedstocks in the chemical sector (e.g. high value chemicals).

In the following industry sections the use of hydrogen for the production of ammonia, high value chemicals, iron & steel and fuels is analysed. In these sectors hydrogen, primarily used as feedstock, is crucial for decarbonisation. By 2050, these sectors could make up around 80% of hydrogen demand in industry with the remaining hydrogen demand coming from industrial heat. To better understand where and by when hydrogen is required in those energy-intensive industries installation-specific¹⁰ decarbonisation roadmaps were created. The bottom-up pathways are informed by company announcements, sector decarbonisation roadmaps and interviews with relevant stakeholders. Although there is a risk of relocation, both within and outside of Europe, due to high costs for decarbonisation, we assume that policy measures are put in place that prevent relocation and carbon leakage. At the same time, relocation of fuel or steel production within Europe, for instance to renewable energy abundant regions in Spain or the Nordics, is also possible. However, in case of an EHB, hydrogen can be transported at low cost across Europe to the benefit of industrial sites located in regions with little renewables potential. This study assumes that in these cases the hydrogen could be transported instead of relocating the industry. Each installation is associated with a certain NUTS 2 region¹¹. If an installation starts using green or blue hydrogen, demand in the respective NUTS 2 region for hydrogen increases.

8 <https://www.eea.europa.eu/data-and-maps/daviz/ghg-emissions-by-aggregated-sector-5#tab-dashboard-02>

9 <https://www.eea.europa.eu/publications/trends-and-drivers-of-eu-ghg>

10 Only installations currently covered by the EU-ETS are included.

11 Nomenclature of Territorial Units for Statistics or NUTS (French: Nomenclature des unités territoriales statistiques) is a geocode standard for referencing the subdivisions of countries for statistical purposes. The current NUTS classification, dated 21 November 2016 and effective from 1 January 2018 (now updated to current members as of 2020), lists 92 regions at NUTS 1, 244 regions at NUTS 2, 1215 regions at NUTS 3 level.

Apart from hydrogen demand in the focus sectors, mainly as feedstock, additional demand can arise in the remaining industry, for industrial heat. Section 2.1.5 analyses demand for hydrogen in low-, medium- and high-temperature industrial processes. While full electrification is expected for low-temperature heat due to the availability of suitable technologies and the associated efficiency gains compared to combustion processes, hydrogen will play a larger role in decarbonising medium- and especially high-temperature processes.

The following figures show the demand for green and blue hydrogen demand per NUTS 2 region (grey hydrogen demand is not shown). As displayed in Figure 2, there is already significant hydrogen demand in 2030 (293 TWh) mostly coming from fuel/HVC production. It is important to note that hydrogen demand for HVC is located at the fuel production installation (see section 2.1.3). There are already pronounced hydrogen demand hubs, most notably in Northwest Europe and parts of Southern Italy, Spain and France. Further, limited, hydrogen demand is scattered across Europe. As these maps are based on current production locations, new industrial hydrogen hubs such as around steel production in North Sweden with a potential hydrogen demand of 30-40 TWh/year¹², or e-fuels production in the Nordics are not portrayed in these maps.

FIGURE 2

Expected industrial green and blue hydrogen demand 2030 based on industry decarbonisation roadmaps of existing installations (in TWh/year)

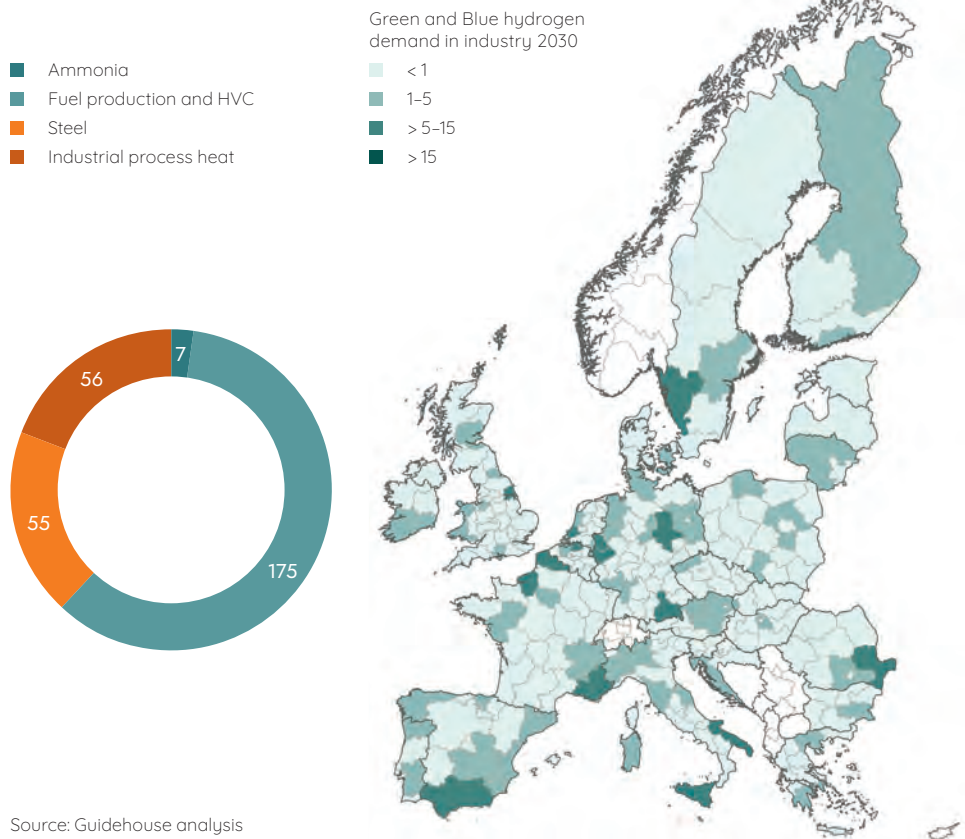

By 2040, hydrogen demand in fuel/HVC production, iron & steel, ammonia and industrial process heat is expected to grow exponentially to 836 TWh per year (see Figure 3). Northwest Europe and parts of Southern Spain, Italy and France continue to be the largest demand region. There is also a growing hydrogen demand in Eastern Europe, e.g., in Romania.

¹² Based on 48 TWh/y of electricity demand for hydrogen production taken from Fossil Free Sweden (2020) p.26: <https://fossilfrittssverige.se>

FIGURE 3

Expected industrial green and blue hydrogen demand 2040 based on industry decarbonisation roadmaps of existing installations (in TWh/year)

- Ammonia
- Fuel production and HVC
- Steel
- Industrial process heat

Green and Blue hydrogen demand in industry 2040

- < 1
- 1-5
- > 5-15
- > 15

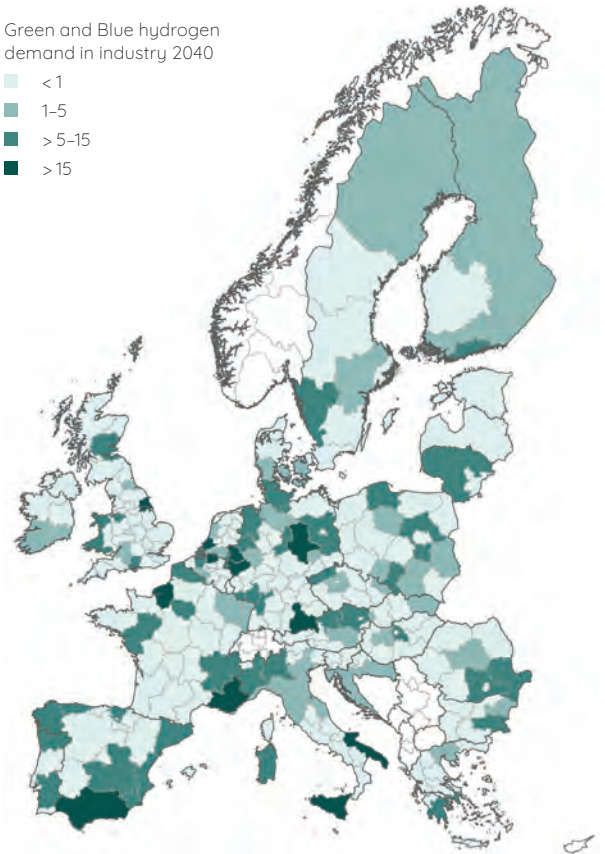
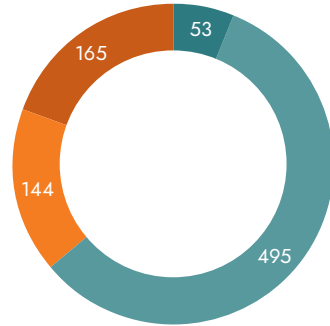

Source: Guidehouse analysis

FIGURE 4

Expected industrial green and blue hydrogen demand 2050 based on industry decarbonisation roadmaps of existing installations (in TWh/year)

- Ammonia
- Fuel production and HVC
- Steel
- Industrial process heat

Green and Blue hydrogen demand in industry 2050

- < 1
- 1-5
- > 5-15
- > 15

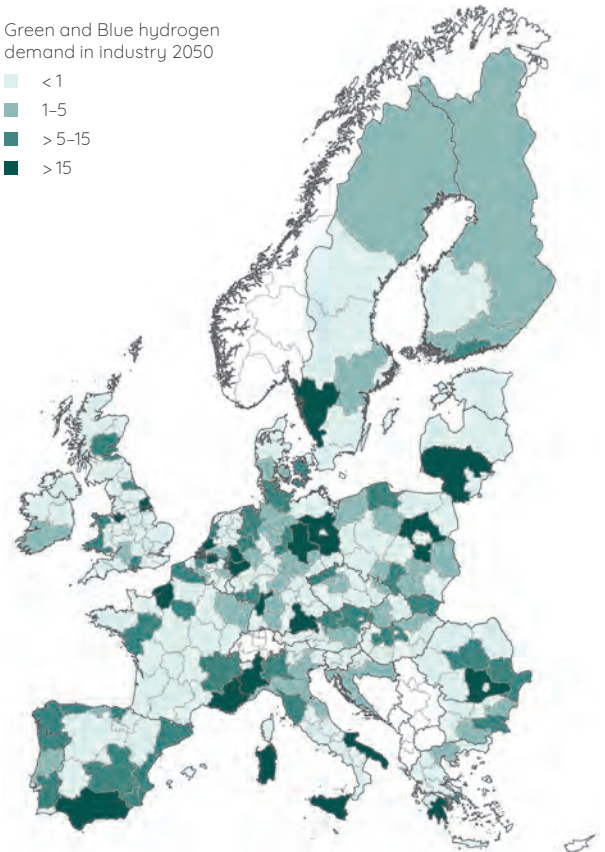
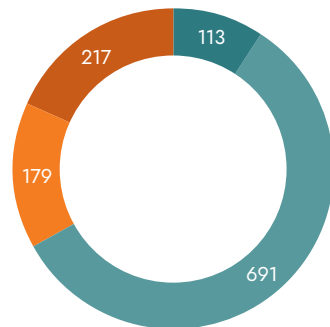

Source: Guidehouse analysis

By 2050, hydrogen demand in industry grows further and is expected to be spread across Europe (see Figure 3) and total demand is estimated to reach 1,200 TWh per year.

Figure 5 summarises the forecasted industrial hydrogen demand per country by each industrial sector in 2030, 2040, and 2050.

Figure 5

Summary of industrial green and blue hydrogen demand in 2030, 2040, 2050 by country based on current install¹³

- Ammonia
- Fuel and HVCs
- Steel
- Industrial process heat

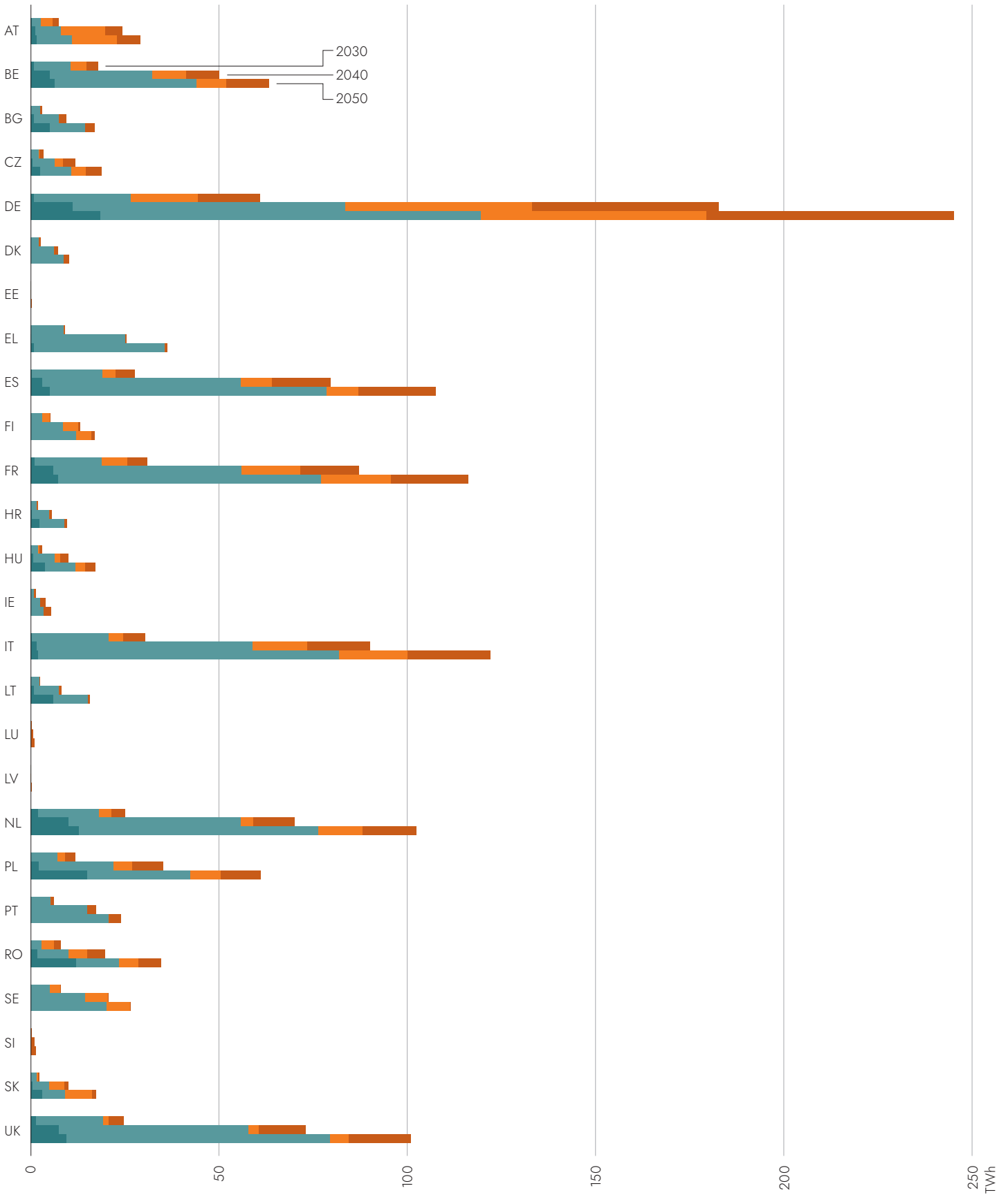

13 Countries with no projected industrial hydrogen demand are not shown

Source: Guidehouse analysis

2.1.1. Iron & steel

Key messages

- This study has performed an installation-specific bottom-up analysis to estimate hydrogen demand in steelmaking. A combination of the widely available and often detailed decarbonisation strategies of Europe's steelmakers, interviews with the steelmakers and inhouse expertise were used to determine a specific transformation pathway up to 2050 for every primary steel plant in the EU+UK.
- Direct reduction of iron ore using hydrogen (DRI) is foreseen as the solution to decarbonise primary steelmaking, next to an increase in secondary steelmaking using recycled steel (scrap). By 2050, a 50/50 split between primary and secondary steelmaking is expected, where in primary steel making hydrogen DRI will become the main production method. In the intermediate period, other decarbonisation routes such as CCUS and using natural gas in DRI are assumed to play a role when hydrogen is not yet available at the large scale required (~7 TWh/year of hydrogen for the average primary steel plant).
- Hydrogen demand in steel making is forecasted to be 55 TWh/year by 2030 and hereafter almost triple to 143 TWh/year by 2040. By 2050, hydrogen demand in fully decarbonised steel sector in the EU+UK is foreseen to be 179 TWh/year.

The steel sector today is the largest industrial emitter of CO₂ in Europe, emitting 22% of industrial GHG emissions and 4% of Europe's total emissions.¹⁴ Today's steel production in EU+UK is split up in primary (59%) and secondary (41%) steel making.

For primary steelmaking in Europe the predominant production method is integrated steel making or Blast Furnace/Basic Oxygen Furnace (BF/BOF), using iron ore as feedstock next to coke and coal, which are also the main energy carriers. In the EU+UK, around 30 larger BF/BOF steel making plants produced on average 100 million tonnes of steel per year between 2010 and 2018. These large plants have an average production capacity of 3.75 Mt/year, the largest being ThyssenKrupp Steel's plant in Duisburg, Germany and ILVA in Taranto, Italy – both can produce around 11.5 Mt/y of crude steel.

In secondary steelmaking the main route is Scrap-Electric Arc Furnace (Scrap-EAF), which uses scrap (recycled steel) as feedstock and electricity as main energy carrier, while also needing a limited amount of natural gas or coal for its carbon content. The more dispersed ~130 Scrap-EAF plants in EU+UK produced around 65-70 Mt/y between 2010- 2018 and are significantly smaller in size; the average production capacity of a Scrap-EAF plant in the EU+UK is around 0.615 Mt/year¹⁵.

Decarbonisation options

Primary steel making: The decarbonisation of primary steel involves replacing the energy carrier and reducing agent¹⁶ in the process, coke/coal, with a fossil-free alternative and to fully decarbonise also the process itself needs to completely transform, moving away from the BF-BOF route. **Direct reduction of iron (DRI) with hydrogen** is seen as the prime solution to decarbonise primary steel making, confirmed by major steelmakers in Europe such as SSAB, Voestalpine, Thyssenkrupp steel, Salzgitter and Liberty Steel¹⁷.

In hydrogen-based steel making, hydrogen is used to directly reduce iron in a direct reduction (DR) plant to produce sponge iron, which in turn can be melted in an EAF to produce steel. To facilitate transportation, it can also be compacted into hot briquetted iron (HBI). This production route requires 1.88 MWh (56.3 kg) of hydrogen per ton of crude steel. Assuming an average primary steel plant of 3.75 Mt/y, this would lead to a substantial hydrogen demand of 7.05 TWh/year for the average European primary steel plant.

14 Roland Berger (2020) available at <https://www.rolandberger.com/en/Insights/Publications/Europe's-steel-industry-at-a-crossroads.html>

15 <https://www.eurofer.eu/assets/Uploads/European-Steel-in-Figures-2020.pdf>

16 Removing oxygen chemically from a substance is called reduction. The industrial production of iron involves reducing iron oxide in a Blast Furnace. Most of the iron oxide is reduced using carbon monoxide gas. This gas is a reducing agent which takes the oxygen away from iron oxide.

17 Taken from company websites.

However, on the road to decarbonisation by 2050 via DRI with hydrogen different alternatives provide for intermediate solutions, as the hydrogen DRI process would be dependent on the availability of large amounts of cheap hydrogen.

In the intermediary period, (1) natural gas or biomethane can be used instead of hydrogen in a DR plant, or on the other hand (2) a first step could be to inject hydrogen in the Blast Furnace to replace part of the coal or coke. An alternative (3) would be to capture and store the CO₂ (CCS) or use it in the production of synthetic fuels or chemicals (CCU). The production of synthetic products using carbon captured from the Blast Furnace flue gases, as for instance ThyssenKrupp steel's Carbon2Chem¹⁸ project, would require a substantial amount of hydrogen, 5.05 MWh (151.5 kg)¹⁹ of hydrogen per ton of crude steel.

Next to hydrogen-based steelmaking, an increase of secondary steel making is expected, increasing its share from 40% now to 50% by 2050, still being limited by the availability of scrap.

Secondary steel making: The decarbonisation of secondary steel does not come with a complete transformation of the process, but merely with switching to renewable electricity, while additionally the limited amount of natural gas needed in the EAF could be replaced with biomethane or synthetic methane which would lead to additional hydrogen demand.²⁰

Pathway towards 2050

This study has performed an installation-specific bottom-up analysis to estimate hydrogen demand in steelmaking. A combination of the widely available and often detailed decarbonisation strategies of Europe's steelmakers, interviews with the steelmakers and inhouse expertise were used to determine a specific transformation pathway up to 2050, for every primary steel plant in the EU+UK. Below some illustrative examples of the decarbonisation pathways of exemplary plants are described. Additionally, some general assumptions were made and applied to all plants. The production capacities of the steel plants were taken from the European steel association EUROFER²¹ and an 80% utilisation rate is assumed. The change in European steel production is taken from Material Economics' modelling based on EUROFER, which yields a ~0.6% yearly increase in the steel stock/capacity up to the 2040s, when it stabilises at 193 million tonnes per year, up from 170 million tonnes per year today. At the same time, the share of secondary steel production is expected to increase to 50%, as less scrap will be exported out of Europe to now serve decarbonisation of steel production in the European market.²² In this study the increase of scrap use is incorporated by downsizing the DR plant compared to the EAF with ~8% of capacity, for every steel plant switching to DRI-EAF steel making. Below some illustrative examples of the decarbonisation pathways of exemplary plants are described. Another notable example not mentioned below would be Salzgitter in east Germany which in their gradual switch to hydrogen DRI steelmaking also showcases the use of waste heat from steel production in with high temperature electrolysis to reach electrolyser from Sunfire reaching high electrical efficiency of up to 84% (LHV)²³.

– ThyssenKrupp Steel Europe Duisburg (Germany)²⁴: Europe's largest plant in terms of production with a capacity of 11.5 Mt/year of steel has set out to fully decarbonise by 2050. The strategy here is to introduce CCU (Carbon2Chem) while at the same time changing the four blast furnaces to (hydrogen operated) DR plants. The DR plants will also be able to partially or totally use natural gas in the transition period, if hydrogen is not available at the required scale. This transition is forecasted to lead to a hydrogen demand of 8 TWh/year already by 2030, 15 TWh/year by 2040 and 18 TWh/year by 2050, using the general assumptions as stated above. Note that the scale up of the Carbon2Chem project would lead to additional hydrogen demand of ~10 TWh/year from 2030 onwards, to avoid double counting we assume this hydrogen demand to be included in the fuel production section of this study.

18 ThyssenKrupp (2020) available at <https://www.thyssenkrupp.com/en/newsroom/content-page-162.html>

19 For the CCU route it is assumed to be always combined with hydrogen injection into the blast furnace, as the route complement one another in terms of efficiency

20 The potential for additional hydrogen demand for synthetic methane to replace natural gas in secondary steelmaking is not considered in this analysis.

21 Available at <https://www.eurofer.eu/about-steel/learn-about-steel/where-is-steel-made-in-europe/>

22 <https://www.eurofer.eu/assets/Uploads/EUROFER-Low-Carbon-Roadmap-Pathways-to-a-CO2-neutral-European-Steel-Industry.pdf>

23 GrInHy2.0 project. Available at <https://www.green-industrial-hydrogen.com/>

24 Available at <https://www.thyssenkrupp-steel.com/en/company/sustainability/climate-strategy/climate-strategy.html>

- SSAB Luleå, Oxelösund (Sweden) and Raahе (Finland)²⁵: SSAB, which has three plants in the Nordics with a total production capacity of 6 Mt/year of steel, is planning to be carbon neutral already by 2045, which would reduce Swedish CO₂ emissions by 10% and Finnish by 7%. Working together with energy company Vattenfall and iron ore producer LKAB, it is currently building the pilot of hydrogen-based reduction and smelting plants, called “HYBRIT”, and plans to transform all the BF’s to EAF’s in the three locations between 2030-2040. This would lead to hydrogen demand of 5 TWh/year by 2030 and 10 TWh/year by 2040 and onwards in the model.
- ArcelorMittal Ghent (Belgium)^{26,27}: ArcelorMittal wants to be carbon neutral by 2050. In its 5 Mt/year plant in Ghent it plans to use CCU (‘smart carbon’) converting carbon containing gas to produce Ethanol or “Steelanol”, while also transporting waste gases (CO/CO₂) to Dow Chemical in Terneuzen (the Netherlands), where it is used in the production of synthetic naphtha. Next to this, ArcelorMittal also replaces coal in the blast furnace with biomass. This study assumes that the CCU route is temporary and considering the investment cycle with the only recently relined blast furnaces; a (full) switch to the DRI-EAF route is only expected by 2050. Leading to a 4 TWh/year hydrogen demand in 2030 and 2040 which increases to 8 TWh/year by 2050, in the model.
- Liberty Steel Ostrava (Czech Republic)²⁸ and Galati (Romania)²⁹: The two Liberty Steel plants in Czechia and Romania, with 3.6 and 3.2 Mt/year of capacity, are set to become carbon neutral by 2030, following Liberty Steel’s ambitious 2030 carbon neutrality target. The plant in Ostrava will completely switch to secondary steelmaking. Hereby, Liberty Steel will transform the integrated steelmaking plants into hybrid plants allowing a gradual switch to use scrap as the only feedstock, leading to an emissions reduction of 60% by 2023 and 100% by 2030. The plant in Galati aims to replace the BOF with one 2.5 Mt/year DRI plant and two EAFs, also already by 2030 leading to a hydrogen demand of over 3 TWh/year, in the model. At the time of writing, Liberty Steel was experiencing serious financial problems, with an unknown impact on its emission reduction plans.

25 Available at <https://www.ssab.com/company/sustainability/sustainable-operations/hybrit>
 26 Available at https://automotive.arcelormittal.com/news_and_stories/news/2020Oct_EuropeGreenSteel
 27 AD Little (2020) Available at https://www.smartdeltaresources.com/sites/default/files/inline-files/200911_SDR_%201%20GW%20Electrolyzer_FINALReport_vEXTERNAL_1.pdf
 28 <https://www.futurenetzero.com/2020/11/12/liberty-steel-launches-tender-for-green-furnaces-at-ostrava/>
 29 <https://www.metalbulletin.com/Article/3936788/Liberty-Steel-to-install-EAFs-DRI-module-to-make-Galati-plant-in-Romania-carbon-neutral-by-2030.html>

Figure 6 shows the annual energy demand for steel in TWh up to 2050. An overall decrease in energy demand despite growing steel production results from the more energy-efficient scrap-EAF and hydrogen DRI-EAF processes. Hydrogen demand in steel making is forecasted to be 55 TWh/year by 2030 and 143 TWh/year by 2040. By 2050, hydrogen demand in fully decarbonised steel sector in the EU+UK is foreseen to be 180 TWh/year. A small share of natural gas and PCI (pulverized coal injection) is still needed for the carbon in the steel, both would come from biogenic sources.

FIGURE 6

Expected development of annual energy demand in steelmaking from 2020-2050

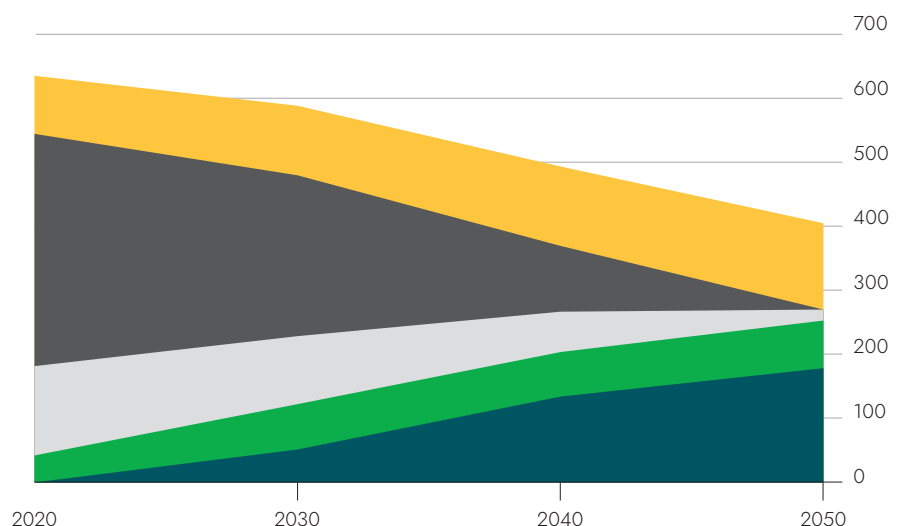

Source: Guidehouse own analysis with installation specific pathways based on company announcements

This analysis is bottom-up and does not consider two potential threats to steel production in Europe: (1) partial relocation and (2) the increase of steel imports. Since the decarbonisation of steel requires vast amounts of hydrogen and electricity (in the case of green hydrogen), production might shift to locations with more favourable conditions for renewable energy, inside or outside of Europe. An example are the plans in north Sweden, where a new player in the steel market, H₂ Green steel³⁰, plans to produce 5 million tons of hydrogen-based steel before 2030 using Sweden's excellent wind conditions.

In hydrogen-based steelmaking the production could even be split up, where the DR plant would be relocated to RES abundant countries, as the HBI which it produces is solid and relatively easily transported and then further melted in an EAF elsewhere. When decoupling the DR plant from the EAF plant, the loss of this 'hot connection' would cause some efficiency losses, but these losses could be compensated by the cheaper hydrogen. An example once more in north Sweden, where LKAB plans to at large scale produce and export sponge iron, instead of the iron ore it exports today³¹. This could lead substantial additional hydrogen demand of 30-40 TWh/year of hydrogen demand in north Sweden³².

However, the European Hydrogen Backbone could provide an alternative to relocation by transporting the hydrogen instead of the end-product, in this case steel or sponge iron. Moreover, steel plants in Europe are often integrated into larger industrial clusters (e.g. the ThyssenKrupp steel site in Duisburg is integrated in the Ruhr cluster, one of the largest industrial clusters in Europe) and (partial) relocation would have a severe impact on integrated value chains, while also the impact on employment in these regions would need to be considered.

2.1.2. Ammonia for fertilisers

Key messages

- In the absence of information on installation specific decarbonisation routes, we assumed steam methane reforming (SMR) with CCS, water electrolysis, and biomethane as the main decarbonisation options and estimated their implementation based on projected readiness of technology, cost competitiveness and attitude towards CCS.
- Production capacity of ammonia is projected to remain constant at 19.1 Mt/y, translating to 113 TWh/year of hydrogen. The existing production of grey hydrogen will gradually be replaced with blue hydrogen, especially in the short-term, while green hydrogen and biomethane will play a larger role in the mid- to long-term. Demand for green and blue hydrogen is expected to be 7 TWh/year in 2030, 53 TWh/year in 2040 and 113 TWh/year in 2050.
- Provided technological advances occur, ammonia could become a fuel for the maritime sector, which would increase demand. Furthermore, there is already an established ammonia trade, so ammonia imports from regions with low-cost hydrogen production could threaten European ammonia production.

Ammonia is a foundational chemical of the fertiliser industry, used both as a fertiliser itself and as a building block for other fertiliser chemicals, such as ammonium nitrate. Roughly 90% of global ammonia production is for the fertiliser industry. Ammonia is produced via the Haber-Bosch process, in which nitrogen is reacted with hydrogen. The nitrogen feedstock is extracted from the air. The hydrogen is traditionally produced from fossil fuels by SMR, producing CO₂ in the process.

30 <https://www.H2greensteel.com/home>

31 <https://www.lkab.com/en/news-room/press-releases/historic-transformation-plan-for-lkab-the-biggest-thing-we-in-sweden-can-do-for-the-climate/>

32 [Hydrogen_strategy_for_fossil_free_competitiveness_ENG.pdf](#) (fossilfritt Sverige.se)

Ammonia is produced in many countries across Europe (19,132 kt/y total in 2019), with the largest production in Germany (3,130 kt/y), Poland (2,520 kt/y), the Netherlands (2,140 kt/y), Romania (2,020 kt/y), and the UK (1,595 kt/y). Most of Europe's ammonia trade is conducted within Europe, with imports and exports nearly equal.³³ Some fertiliser chemicals, namely urea and its derivatives, contain carbon. Urea is produced by reacting ammonia with CO₂ produced by the SMR. Therefore, in order to continue to produce urea, producers must either produce ammonia in a way that also produces CO₂ or source CO₂ from elsewhere. Urea and its derivatives account for approximately 35% of fertiliser production in Europe.³⁴ Current ammonia production generates 1.83 tonnes of CO₂ per tonne of ammonia on average, and 1.3% of total CO₂ emissions in the EU³⁵. Two thirds of emissions are process emissions from the upstream hydrogen production from SMR, and the remaining emissions are from the combustion of fuels for heat and compression.

Decarbonisation options

Today, fossil hydrogen produced via SMR is the industry standard feedstock for ammonia production. In our analysis, we identified three decarbonisation options for the ammonia industry, all focused on the upstream hydrogen production step in ammonia production where the bulk of emissions occur.

Carbon capture: CCS can be applied to SMR to switch from fossil to blue hydrogen production in order to reduce emissions from ammonia production by up to 95%. While the first 60-65% is relatively inexpensive to capture (since it relates to pure CO₂ from the SMR process) the additional 30-35% is less economical.³⁶ Carbon capture leads to additional electricity consumption because the captured CO₂ needs to be compressed, transported, and stored.

Water electrolysis: Green hydrogen can be produced via electrolysis to replace the SMR. Electrolysis of water consumes about 10.8 MWh of electricity per tonne of ammonia, and if renewable electricity is used to power all equipment, this pathway reduces total emissions to zero.

Biomethane: Without any changes to the process itself, the natural gas feed used for SMR is replaced by biomethane, resulting in carbon neutrality. Furthermore digestate, the by-product of biomethane production, can be used to produce agricultural fertilisers. Since electrolysis does not produce CO₂ and Europe's energy system will shift away from fossil fuels, using biomethane may be the only acceptable long-term urea production pathway. Note that CO₂ is required for urea production only, not ammonia production.

Installations that produce blue hydrogen using CCS may later use biomethane instead of fossil methane (bio energy CCS (BECSS)) as feedstock, leading to negative emissions or climate-positive hydrogen. It is important to note that biomethane will typically be sourced from agricultural regions and much of the blue hydrogen production will be located near natural gas deposits. Assuming the continued existence of a natural gas grid, methane reforming operators can circumvent this by purchasing green certificates for biomethane injected elsewhere.

Urea is a popular fertiliser in part because of its low cost.³⁷ As the industry is decarbonised, urea may become more expensive to produce as biogenic CO₂ will need to be sourced to produce it without generating emissions. Therefore, production and usage may decrease.

33 <https://oec.world/en/profile/hs92/ammonia?redirect=true>

34 https://www.fertilizerseurope.com/uploads/media/Industry_Facts_and_Figures_2019.pdf

35 Material Economics – Industrial Transformation 2050

36 <https://www.sciencedirect.com/science/article/pii/S1364032114005450>

37 <https://www.noble.org/news/publications/ag-news-and-views/2006/july/weigh-pros-cons-when-choosing-summer-nitrogen-source/#:~:text=Urea%20has%20several%20advantages%2C%20including,to%20ammonium%20carbonate%20by%20urease.>

Pathway towards 2050

While there are limited company announcements on decarbonisation pathways, national and European chemical associations have identified blue hydrogen production via SMR with CCS or water electrolysis as the primary decarbonisation options.³⁸ For the purposes of this analysis we categorised countries based on whether or not they are likely to be an early adopter of decarbonisation technologies, and whether or not they are likely to implement blue hydrogen. For example, it is assumed that CCS in Germany is reserved for unavoidable process emission (e.g. from cement) due to the Government's critical attitude towards carbon storage and not needed in Spain for blue hydrogen production due to the possibility to produce green hydrogen at large scale relatively cheaply.

Europe's ammonia production for fertilisers is assumed to be constant at roughly 19.1 Mt/year until 2050. Ammonia is also considered as a promising fuel for shipping, but this is not included in this section and further discussed in the fuel production (see 2.1.4) and transport sections (see 2.2.3).

For the decarbonisation pathways we then assumed a breakdown of traditional SMR, SMR with CCS, water electrolysis, and biomethane use in 2030, 2040, and 2050 for each category of country based on the projected readiness of technology and cost competitiveness. In the absence of installation level announcements, the relevant split was applied to each installation based on the country it is located in. For example, all Belgian installations in 2040 are assumed to produce their ammonia from 20% SMR without CCS, 20% SMR with CCS, 50% electrolysis, and 10% biomethane. In reality, each installation will likely only use one pathway, however applying a specific pathway to each installation would be arbitrary and would skew the analysis of energy carrier demand on a NUTS 2 level.³⁹ SMR is gradually replaced mostly by electrolysis. SMR with CCS using natural gas is used in 2030 and 2040, however by 2050 it is replaced by electrolysis and biomethane to meet the long-term goal of a climate neutral European energy system.

Figure 7 shows the projected annual demand for each energy carrier for ammonia production through 2050 in TWh/year. Total hydrogen demand for ammonia production remains constant at 113 TWh/year. Grey hydrogen is gradually replaced by green and blue hydrogen starting in 2030 due to decreasing costs of decarbonisation technologies and increasing CO₂ prices.

- 38 CEFIC/DECHEMA (2019): Low carbon energy and feedstock for the European chemical industry, https://cefic.org/app/uploads/2019/01/Low-carbon-energy-and-feedstock-for-the-chemical-industry-DECHEMA_Report-energy_climate.pdf; VCI (2019): Auf dem Weg zu einer treibhausgasneutralen chemischen Industrie in Deutschland, <https://www.vci.de/vci/downloads-vci/publikation/2019-10-09-studie-roadmap-chemie-2050-treibhausgasneutralitaet.pdf>; VNCI (2018): Roadmap for the Dutch Chemical Industry towards 2050, https://vncl.nl/Content/Files/file/Downloads/VNCL_Routekaart-2050.pdf
- 39 NUTS (Nomenclature of territorial units for statistics) is a system for dividing the economic territory of the EU and UK for statistical purposes

FIGURE 7

Development of the European annual hydrogen demand in ammonia production from 2020-2050

- Green and blue hydrogen
- Grey hydrogen

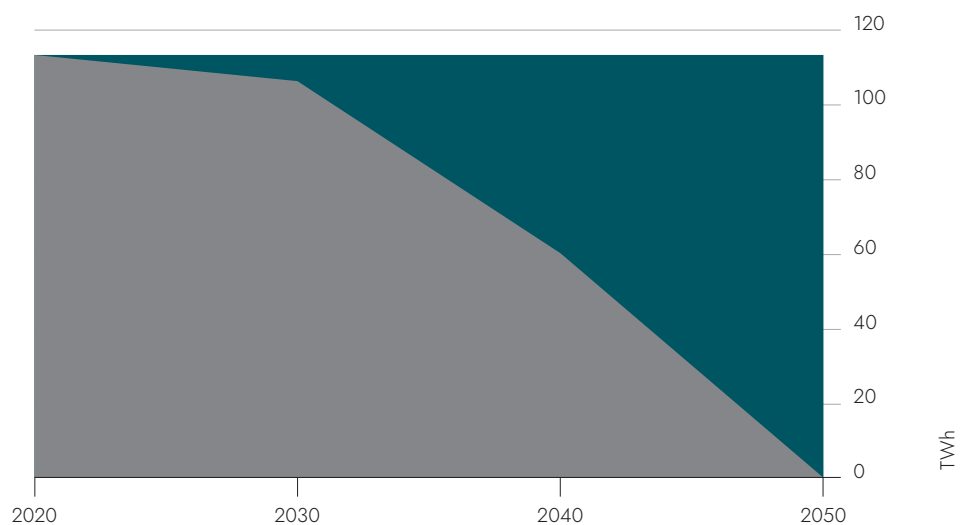

Source: Guidehouse analysis

While there is a strong push by national governments and the EU to support the net-zero transition of the chemical industry, for ammonia there is a real risk of relocation. Ammonia is already widely traded internationally and is generating interest as a potential zero-carbon fuel, which would increase the scale of production and trade. Therefore, European ammonia production could relocate to areas outside of Europe with cheap renewables. For the purpose of this analysis we did not examine global costs of ammonia production and transport. We assumed that European production will remain competitive with imports due to a favourable regulatory environment and because transport will increase the cost of imported ammonia.

2.1.3. High value chemicals

Key messages

- There is still a lot of uncertainty around the decarbonisation of High Value Chemicals (HVCs) – mainly used in plastics production. Therefore, a homogenous approach is applied to all existing HVC production sites. In reality, different locations will choose different pathways for the process and feedstock decarbonisation, very much dependent on the available feedstocks such as hydrogen and biomass.
- This study therefore assumes an end-state in 2050 with an even three-way split between the process decarbonisation options (cracking, methanol-to-olefins and conventional steam cracking with a decarbonised energy carrier) and the three naphtha or methanol feedstock decarbonisation options (synthetic, bio-based and chemically recycled). Hydrogen demand is forecasted at 67 TWh in 2030, 164 TWh in 2040 and 291 TWh. The hydrogen demand for the feedstock is assumed to be located at fuel production sites, as it is today and thus it is included in the fuel production section (see 2.1.4).

HVCs in the EU+UK are produced in steam crackers, where long-chain hydrocarbons are cracked into short-chain hydrocarbons. The main HVCs are ethylene, propylene, butadiene (also referred to as olefins), benzene (representative for the aromatics), while also hydrogen and methane are produced in the cracking process. The main feedstocks used in steam cracking in the EU+UK are naphtha (70%), gas oil (10%), and gasses like ethane, butane and propane (17%). These feedstocks are also used as energy carrier, roughly 30% of their energy content is burned in the energy-intensive cracking process (700-900°C). The HVCs which are produced, mostly ethylene and propylene, are widely traded products and used to produce plastics, and a range of other products.

The EU+UK currently counts ~55 steam crackers, with an average production capacity of just under 0.5 Mt/y per installation. One of the largest steam crackers in the EU+UK is currently being constructed by Ineos Antwerp, with an ethylene capacity of 1.25 Mt/y⁴⁰, after which the Antwerp/Rotterdam region will have 23% of the EU+UK cracking capacity in terms of ethylene. In Northwestern Europe, the steam crackers are usually integrated in large industrial/petrochemical clusters. Germany, Netherlands and Belgium together account for 42% of the EU+UK ethylene production capacity.

Decarbonisation options

The production of HVC in the EU+UK accounts for about 18% of Europe's chemical GHG emissions⁴¹ and the decarbonisation pathways per company or specific installation are largely unknown. This study structures the decarbonisation twofold – into the process and the feedstock:

“To achieve the politically defined decarbonisation goal by 2050, the hydrogen demand of the chemical industry will increase significantly in the future. Considerable long-term reinvestments in production plants and infrastructure are required over the next few decades, if we want to keep our chemical industry base in Europe. For that we need an investment-friendly framework alongside the confidence of the industry in a secured availability of sufficient quantities of competitively priced hydrogen. The EHB contributes significantly in providing that.”

Detlev Wösten
Chairman VCI Nord

40 http://www.mrcplast.com/news-news_open-382294.html

41 https://ec.europa.eu/clima/sites/clima/files/ets/allowances/docs/bm_study-chemicals_en.pdf

Process: Three options exist for the cracking process to decarbonise:

- **Change of feedstock (in the cracking process):** The first would not need any alterations to the cracker or process but merely change its fossil feedstock (naphtha, gas oil, ethane, butane etc.) into a decarbonised fuel, e.g., bio- or synthetic naphtha or a chemically recycled feedstock (pyrolysis oil).
- **Electrifying the cracking process:** It would provide a less resource-intensive decarbonisation option for the cracking process. However, electric crackers do not yet exist, although the world's largest petrochemical companies are currently developing this technology (BASF/Linde/SABIC⁴² and Shell/DOW⁴³).
- **Complete transformation of the process and feedstock to produce HVCs (MtO):** This means to convert methanol to ethylene, propylene and butadiene, a process which is called Methanol-to-Olefins (MtO). This process is already applied at scale with fossil-based methanol in for instance China⁴⁴. But in this case, the methanol feedstock would need to be decarbonised too.

Feedstock: The feedstocks to produce HVCs, naphtha, gas oil and gases like ethane, butane and propane, are not easy to decarbonise as they need to contain carbon, which ends up in the HVCs and final products, such as plastics. Three main options exist for both (1) the feedstock in the cracking process, as well as (2) the methanol in MtO:

- **Chemical recycling:** The first and least resource-intensive option is chemically recycled feedstock, where pyrolysis oil from non-recyclable plastic waste is turned into feedstock for the cracking process, trialled by SABIC in the Netherlands⁴⁵. Methanol for MtO can also be produced from non-recyclable plastic waste, a process referred to as **waste-to-methanol**, trialled by among others Shell and Enkema in Rotterdam⁴⁶. Other residue waste flows could also provide an option here, although plastic waste would be the most obvious and circular one.
- **Bio-based:** The second option would be to use biomass to produce naphtha or methanol. Bio-naphtha would be made by severe hydrocracking, as done by Neste⁴⁷, while bio-methanol can be produced using gasification or anaerobic digestion⁴⁸.
- **Synthetic:** The third option considered is to use electricity as basis to produce synthetic naphtha or methanol. This process requires a lot of energy while a source of carbon is also needed. The "Steelanol" project from ArcelorMittal and Dow Chemical around Ghent⁴⁹ uses the carbon from steel production, but in the future this process would need a biogenic source or direct air capture (DAC) of CO₂ to be carbon neutral.

Table 1 shows the hydrogen demand for the different feedstock decarbonisation routes. For simplicity reasons only naphtha is considered as input for the electric and steam cracker. The substantial range in hydrogen demand per ton of HVCs, from 0 to 15.75 MWh, shows the large possible impact on hydrogen demand of HVCs production. The decisive factors in assessing the future role for each of the different routes are the costs and availability of resources for the three feedstock routes (chemical recycling, bio-based, synthetic). These resources are mainly (non-recyclable) plastic waste for chemical recycling, biomass for the bio-based route for the biogenic routes and hydrogen and biogenic or direct air capture (DAC) CO₂ for the synthetic route. In cracking, hydrogen is also produced as by-product in the process, at around 1% on a weight basis per ton of HVC for naphtha cracking⁵⁰.

42 <https://www.basf.com/global/en/who-we-are/sustainability/whats-new/sustainability-news/2021/basf-sabic-and-linde-join-forces-to-realize-worlds-first-electrically-heated-steam-cracker-furnace.html>

43 <https://www.shell.com/business-customers/chemicals/media-releases/2020-media-releases/dow-and-shell-team-up-to-develop-electric-cracking-technology.html>

44 <https://www.methanolmsa.com/mto/>

45 https://energy.nl/wp-content/uploads/2020/09/Pyrolysis-oil-production-from-plastic-waste_28-09-2020.pdf

46 <https://enkema.com/news-release/w2c-rotterdam-project-welcomes-shell-as-partner/#:~:text=Enkem%20produces%20advanced%20biofuels%20and,and%20other%20widely%20used%20chemicals.>

47 <https://greenchemicalsblog.com/2012/11/08/neste-oil-expands-in-bio-naphtha/>

48 <https://www.climate-kic.org/wp-content/uploads/2019/04/Material-Economics-Industrial-Transformation-2050.pdf>

49 <http://www.steelanol.eu/en>

50 <https://dspace.library.uu.nl/bitstream/handle/1874/32318/ren.pdf?sequence=2>

TABLE 1

Range of Hydrogen demand from different feedstocks for HVCs production

Feedstock for HVC production	Hydrogen demand MWh/ton of naphtha or methanol	Hydrogen demand MWh/per ton of HVCs
Bio naphtha ⁵¹	0.78	1.30
Synthetic naphtha	5.85	9.75
Naphtha like pyrolysis oil ⁵²	0.00	0.00
Bio methanol ⁵³	2.00	5.00
Synthetic methanol	6.30	15.75
Waste to methanol	3.33	8.33

Source: Material Economics (2020), Ren (2006), RoyalHaskoning DHV (2018) and own analysis

Pathways towards 2050

The decarbonisation pathway of HVC production in the EU+UK is uncertain, the pathway of the specific installations even more so. Little site-specific information is available, especially in comparison to for instance the steel plants (see 2.1.1). Therefore, this study assumes a homogeneous route for all the different plants, thus assuming the same decarbonisation routes for every plant.

From the production capacities in ethylene and current fossil feedstocks (mostly Naphtha)⁵⁴ per steam cracker, the total HVC production is determined, using the conversion factors of table 2-2 from Ren (2006)⁵⁵, as the output of the steam cracker depends on the feedstock it uses. HVC production could be expected to increase slightly by 2050 due to higher demand for plastics. However, this increase is assumed to be completely compensated by a higher share of mechanical recycling of plastics.⁵⁶ Hence, we assume a constant production capacity of HVCs of 53 million tonnes per year, calculated from 27 million tonnes of ethylene per year.

Given the breadth of decarbonisation options and the absence of installation-specific information on decarbonisation strategies, an even split between the three options is assumed by 2050, thus leading to one-third conventional steam cracking with a decarbonised feedstock, one-third electric cracking and one-third MtO by 2050. We assume that electric cracking will take off later than MtO due to its lower TRL, when compared to MtO.

All three feedstock options (bio, chemically recycled and synthetic) seem equally feasible and no clear direction has been chosen by the industry, so for the time being we assume an equal split between the options. Although the **chemical recycling** route is the preferred route in terms of resource intensity, the route is limited by the availability of plastic waste, and e.g. the Dutch chemical association (VNCI) reported the long-term potential in the Netherlands at around 30%⁵⁷. Seeing the preference for this route, it already has a relatively large share of 30% by 2040, when the technology has matured. The **share of synthetic feedstock** is expected to be limited and come up later in the 2040s due to its energy intensity and dependence on the still immature DAC technology, or limited available biogenic sources of CO₂.

51 In the cracking process hydrogen is also produced as by product (0.56 MWh per ton of Naphtha input); this is subtracted from the hydrogen demand for all routes using naphtha

52 The hydrogen demand for naphtha like pyrolysis oil is unknown and therefore assumed to be equal to the hydrogen production, thus leading to no hydrogen demand – similar as material economics (2020)

53 The Bio methanol route is based on two representative routes from Material Economics (2020), page 127: Gasification and Anaerobic Digestion (50% each). The routes represent the range of potential feedstocks and uses, with the Anaerobic Digestion using -10 MWh of hydrogen per ton of HVCs and Gasification none, while Gasification route would need 3.5 tonnes of dry biomass and Anaerobic Digestion route only 1.9 tonnes per ton of HVCs. The anaerobic digestion route to methanol in terms of process is coming close to synthetic methanol with biogenic CO₂ and could therefore also be categorized as such. However, in this study this route is used to illustrate the range of feedstocks which can be used.

54 <https://www.ogj.com/refining-processing/chemicals/article/17237013/international-survey-of-ethylene-from-steam-crackers-2015>

55 <https://dspace.library.uu.nl/bitstream/handle/1874/32318/ren.pdf?sequence=2>

56 <https://www.climate-kic.org/wp-content/uploads/2019/04/Material-Economics-Industrial-Transformation-2050.pdf>

57 VNCI Routekaart Ecofys (2018) available at https://www.vnci.nl/Content/Files/file/Downloads/VNCI_Routekaart-2050.pdf

Figure 8 below shows the transformation of the feedstock for HVCs with the early adoption of bio-based plastics, with chemical recycling taking off in the 2030s when the technology matured and synthetic methanol and naphtha in the 2040s, when more renewable electricity would be available, and DAC has matured.

FIGURE 8

HVC feedstock transformation from 2020-2050

- Chemically recycled
- Synthetic
- Bio
- Fossil

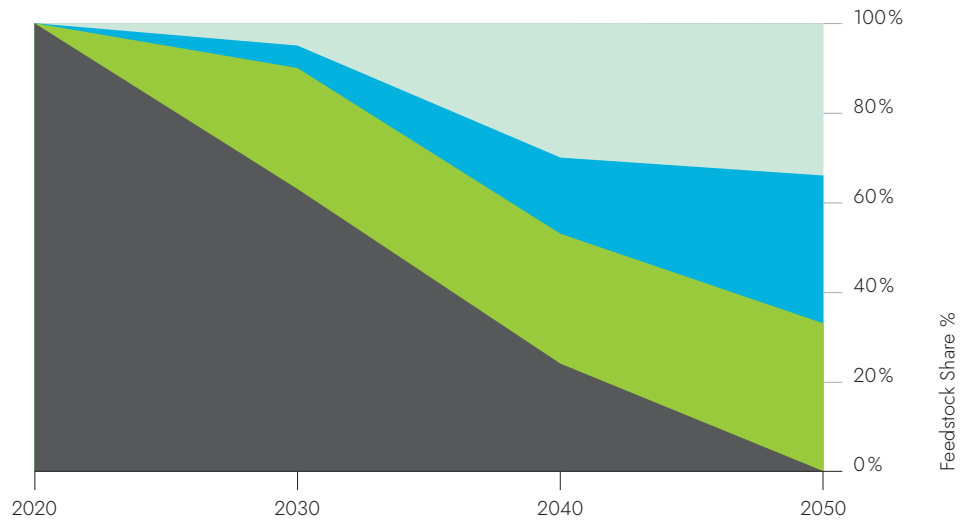

Source: Guidehouse own analysis based on industry roadmaps and Material Economics (2020)

Production location

Today, the naphtha and other fossil-based feedstocks for the steam crackers are produced at refineries either outside or within Europe, and the refineries are also in some cases integrated with the steam crackers in an industrial cluster. This study assumes that, similar as today, in the future the feedstocks for HVC production are (by) produced at refineries.

This assumption represents one scenario with of course significant degrees of freedom. In the future, the decarbonised feedstocks can come from new bio, waste product, or synthetic fuel refineries, of which the location has yet to be determined, while importing is also an option. The locations will depend on the availability and costs of feedstocks and energy carriers and proximity to the HVC plant. This can for e.g. synthetic fuels production mean a relocation to cheap RES abundant regions. However, there are several reasons why this might not be the case and the scenario this study assumes is in fact realistic:

- Current refineries are mostly well-located in industrial clusters and/or port areas which provide opportunities for industrial symbiosis and the option to import feedstocks/energy carriers. Thus, although the production of the decarbonised feedstocks are mostly new processes needing new installations, the strategic location is still of importance.
- The **European Hydrogen Backbone** could provide a cheap transportation option for the large amounts of low-carbon energy needed - in the form of hydrogen - at a constant supply. Thus, transporting the hydrogen to refineries instead of relocating the fuel production to RES-abundant regions and transporting the naphtha/methanol. A green source of carbon would be needed at the same sites.
- Refineries today are integrated with the steam cracker, providing flexibility and ability to use the other plant's by-products. In the future, these advantages remain.

These reasons provide the background for the assumption that all feedstocks for HVC production will be produced at current refining locations. The capacity and following hydrogen demand per refinery location is, similar to the fuels production in section 2.1.4 determined using the current production capacity per refinery compared to the total current oil refining capacity in the EU+UK. The dispersed hydrogen demand to produce the feedstocks for HVCs production totals 67 TWh in 2030, 164 TWh in 2040 and 291 TWh in 2050. This is substantially lower than previous Gas for Climate reports, as in this study chemical recycling and bio-based feedstocks are considered for HVC production, instead of only MtO with synthetic methanol. The hydrogen demand is thus accounted for in the fuel production analysis (see section 1.1.4).

2.1.4. Fuel production

Key messages:

- Fuel production is assumed to remain at the same refining location as today in the EU+UK, where the EHB could play a vital role in transporting the large amounts of hydrogen to fuel production locations. Relocation of fuel production within or outside Europe would also be an option and it is reasonable to expect the eventual end state to fall somewhere in between.
- Hydrogen demand for fuel production is forecasted at 175 TWh by 2030, 495 TWh by 2040 and 691 TWh by 2050. Hydrogen demand from fuel production in this study includes hydrogenation of fossil fuels, upgrading to bio kerosene, synthetic kerosene and fuels for HVCs.

Today fuel production takes place in the EU+UK in about 85 refineries, which have a total capacity of 14.5 million barrels of oil per day and an average production capacity of 175 thousand barrels per day. WoodMackenzie states that almost 10% of refining capacity in Europe is under threat to close before 2023⁵⁸, partly also due to the corona virus pandemic.

Future fuels production in the form of bio-, recycled- or synthetic fuels would not reach the levels of current refining capacity. Synthetic fuel production could be relocated to where its main resources, green hydrogen and thus electricity and CO₂, are abundant and cheap. If the CO₂ would come from DAC it does not need a specific location, although the spatial footprint of DAC is substantial. Hereby, Europe's potential and competitiveness to produce synthetic fuels could be limited, due to the substantial amounts of renewable electricity and land required. Still, it can be argued that, next to the land and permitting, there are more reasons to locate synfuel production at current refinery locations, which were partly already mentioned in the HVCs section.

- Current refineries are mostly well-located in industrial clusters and/or port areas which provide opportunities for industrial symbiosis and the option to import feedstocks/energy carriers. Thus, although the production of the synfuels are mostly new processes needing new installations, the strategic location is still of importance.
- The **European Hydrogen Backbone** could provide a cheap transportation option for the large amounts of low-carbon energy needed - in the form of hydrogen - at a constant supply. Thus, transporting hydrogen instead of relocating fuel production to RES-abundant regions and transporting the naphtha/methanol.

58 <https://www.woodmac.com/news/opinion/european-refining-at-the-rubicon-again--which-assets-will-make-it-over/>

An example is the port of Rotterdam, home to five refineries with in total 8% of EU+UK's current refining capacity, which has ambitious plans for hydrogen and renewable fuels to play a similar role as oil does today with an import and conversion terminal for hydrogen⁵⁹. Rotterdam also has been chosen by Neste for their new "renewable products refinery" due to its resource availability and proximity to renewable aviation, polymers and chemicals markets⁶⁰. On the other hand, new e-fuel projects have been announced in countries with already a high share of renewable energy, where the availability of biogenic sources of CO₂ could also play an important role. An example are the Nordics, where for instance in Finland⁶¹ and Denmark⁶² companies are partnering up to kickstart e-fuel production in these countries.

This study assumes that imports are limited to green ammonia production for shipping, as early signs show already large-scale green ammonia projects emerging outside Europe in the MENA region (e.g. NEOM⁶³), Australia⁶⁴, and Asia⁶⁵. Enabled by the mature technique of nitrogen air separation, the production can move to areas with abundant solar and wind resources and land availability. The remaining carbon-based synfuels production, in this study only synthetic jet-fuel, are spread out over the EU+UK based on current refinery locations and capacities, adding to the fuels used for HVCs production. The synthetic jet fuel demand is taken from the aviation section 2.2.2.

Next to this, hydrogen is also needed in refineries as a feedstock to hydrogenate fossil fuels, which makes refineries actually the main user of hydrogen today⁶⁶. The demand for refining fossil fuels, however, is expected to decrease to zero over time with the phasing out of liquid fossil fuels. The remaining demand, today served by grey hydrogen, is expected to transition to 100% blue and green hydrogen by 2040.

In biofuel refineries biomass also needs to be upgraded using hydrogen, especially in the case of bio jet fuel due to the high energy density required for aviation fuels. The hydrogen demand for upgrading is dependent on the type of biomass, fuel and the process, while at the same time it also produces bio by-products such as (bio) heavy fuel oil or (bio)naphtha. In this study, considering the scope of the transport section, only hydrogen demand for upgrading to bio kerosene is considered, which as mentioned before is also the fuel which needs the most upgrading. The hydrogen demand for upgrading to bio kerosene is dependent on the production method and type of biomass and can range from 0.08 to 0.52 MWh per MWh of bio-kerosene. Here, we assume the average of three technologies used in Ricardo (2019)⁶⁷. The use of hydrogen directly as a fuel is an option, especially in aviation and shipping, but this is not included here in the fuel production section but covered in the transport analysis (see section 2.2).

Hydrogen demand

- **For hydrogenation of fossil fuels** the hydrogen demand today is 138 TWh/year of grey hydrogen, but by 2030 is expected to have a 35% share (40 TWh) of which is green or blue (of the decreased 115 TWh total) and 100% by 2040 (of the further decreased 15 TWh total), while in 2050 no liquid fossil fuels will need to be hydrogenated in the EU+UK⁶⁸.
- **Upgrading/Hydrogenation to bio kerosene** is assumed to require 0.15 MWh of hydrogen per MWh of bio kerosene^{67,69}. Demand for bio kerosene is taken from the aviation section 2.2.2 at 51 TWh in 2030, 235 TWh in 2040, and 295 TWh in 2050. Hydrogen demand for upgrading to bio kerosene then comes to 8 TWh by 2030, 35 TWh by 2040 and 44 TWh by 2050.

59 <https://www.portofrotterdam.com/en/doing-business/port-of-the-future/energy-transition/hydrogen-in-rotterdam>

60 <https://www.neste.com/releases-and-news/renewable-solutions/neste-selects-rotterdam-location-its-possible-next-world-scale-renewable-products-refinery>

61 Splash 247 (2020) <https://splasH247.com/finnish-firms-set-out-to-lead-e-fuel-race/>

62 <https://baltictransportjournal.com/index.php?id=1160>

63 <https://www.airproducts.com/news-center/2020/07/0707-air-products-agreement-for-green-ammonia-production-facility-for-export-to-hydrogen-market>

64 <https://www.spglobal.com/platts/en/market-insights/latest-news/petrochemicals/050421-interview-worlds-largest-green-hydrogen-project-eyes-australian-ammonia-exports>

65 <https://asianrehab.com/>

66 <https://www.fchobservatory.eu/observatory/technology-and-market/hydrogen-demand>

67 Average of 3 technologies from Ricardo (2019) Quantifying future hydrogen demand for upgrading biofuels (page 22). Available at [https://cdn.ricardo.com/ee/media/assets/hydrogen-demand-for-upgrading-biofuels-final-report_v2-\(002\).pdf](https://cdn.ricardo.com/ee/media/assets/hydrogen-demand-for-upgrading-biofuels-final-report_v2-(002).pdf)

68 Agora (2021) https://static.agora-energiewende.de/fileadmin/Projekte/2021/2021_02_EU_H2Grid/A-EW_203_No-regret-hydrogen_WEB.pdf

69 1 ton = 11.94 MWh for kerosene (LHV)

- **Synthetic kerosene** requires 14 MWh (430 kg) of hydrogen per ton or 1.2 TWh per TWh of syn-kerosene⁶⁹, and demand for synthetic kerosene is taken from the aviation section 2.2.2 at 51 TWh in 2030, 235 TWh in 2040, and 295 TWh in 2050. Hydrogen demand to produce synthetic kerosene is in turn forecasted to be 6167 TWh in 2030, 282 TWh in 2040 and 355TWh in 2050.
- **For fuels for HVCs production** the hydrogen demand is calculated in section 2.1.3, at 67 TWh in 2030, 164 TWh in 2040 and 291 TWh in 2050.

Figure 9 below shows the forecasted hydrogen demand from fuel production, at 175 TWh by 2030, 495 TWh by 2040 and 691 TWh by 2050. This hydrogen demand is, as mentioned before, assumed to be located at the refineries and spread out based on the current capacity in barrels per day relative to the total sum of capacity for the EU+UK.

FIGURE 9

Expected development of annual green and blue hydrogen demand for fuel production between 2020-2050

- Fuels for production of HVCs
- Upgrading to bio kerosene
- Synthetic jet fuel production
- Hydrogenation of fossil fuels

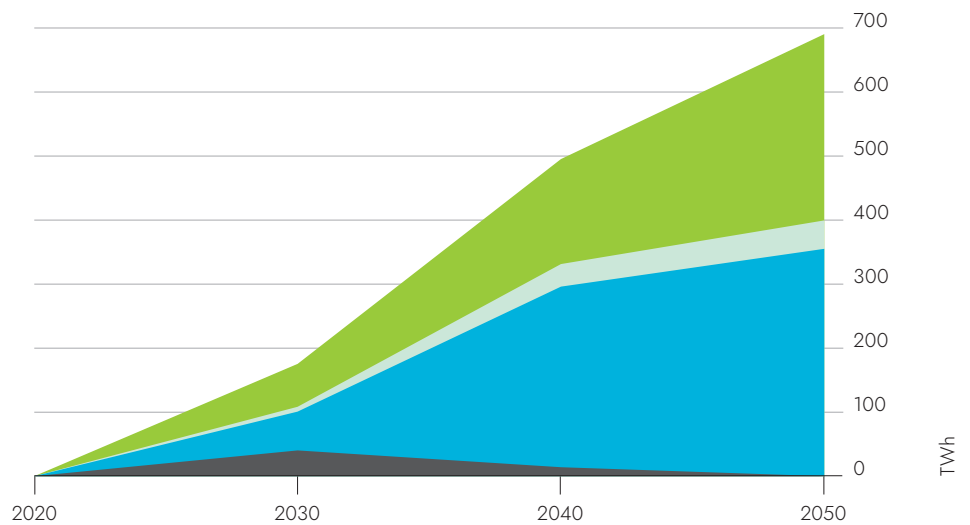

Source: Guidehouse wanalysis

2.1.5. Industrial process heat

The previous industrial sections focused on the demand for hydrogen as a feedstock. In this section, the future use of hydrogen for industrial process heat is analysed. Industrial process heat is defined as thermal energy used directly in the preparation or treatment of materials used to produce manufactured goods and does not include spatial heating (covered in section 2.4). While heating needs for buildings are fairly standard, industrial heat encompasses a wide variety of temperature levels for diverse processes and end-uses. For instance, cement kilns require high-temperature, while drying or washing applications in the food industry operate at lower temperatures. Industrial heat can be categorised in three groups differentiated by temperature requirements:

- **Low-temperature heat below 100°C**, e.g., machinery, transport equipment or wood and wood Products
- **Medium-temperature heat between 100-500°C**, e.g., pulp and paper, food, beverages and tobacco or Textile, Leather, and clothing
- **High-temperature heat above 500°C**, e.g., glass, cement, ceramics or non-ferrous metals

Today, natural gas, amongst other fossil energy carriers, is largely used to provide industrial heat (see Appendix A). To decarbonise industrial heat, a switch to renewable or low-carbon energy is needed. For low-temperature heat, heat pumps and direct electrification are the preferred option because of its increased efficiency compared to gas-based options. In contrast to the buildings sector where full electrification of heat would require a massive build-up of infrastructure to also cover peak demand (e.g. during cold spells), energy demand in industry is more constant and predictable limiting the build-up of infrastructure. For many medium- to high-temperature processes, green and blue hydrogen can be a suitable decarbonisation pathway due to the difficulties associated with direct electrification (e.g. material degradation)

To estimate the future demand for green- and blue hydrogen, we assume certain green- and blue hydrogen shares per temperature level in 2030, 2040 and 2050. For low-temperature heat, we assume fossil energy carriers can be fully replaced by electrification. For medium-temperature heat, we estimate that 5% of today's natural gas for industrial heat will be replaced by 2030 with green and blue hydrogen, 20% by 2040 and 30% by 2050. For high-temperature heat, 15% of natural gas will be replaced with green and blue hydrogen by 2030, 40% by 2040 and 50% by 2050. In addition it should be noted that green and blue hydrogen could also replace other fossil energy carriers. In reality, the penetration of green and blue hydrogen will vary significantly by region - hydrogen could e.g. take up a more substantial share of industrial heat demand in countries such as Spain where biomass and CCS constraints are more prominent. Remaining fossil fuel uses could be replaced with electricity or other renewable and low-carbon gas such as biomethane.

Figure 10 shows the development of hydrogen demand for industrial process heat. While there is no expected hydrogen demand for low-temperature heat, hydrogen demand for medium and, in particular, high-temperature heat is significant. By 2030, we expected 56 TWh/year for industrial process heat tripling to 165 TWh/year in 2040 and 217 TWh/year in 2050.

FIGURE 10

Expected annual green and blue hydrogen demand for industrial process heat based on current production (based on FFE data)⁷⁰

■ High
■ Medium

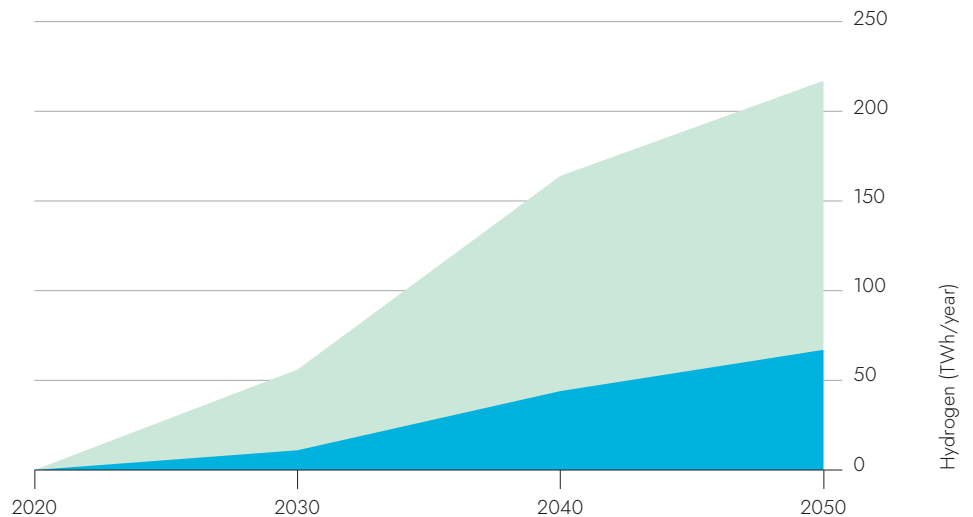

Source: Guidehouse analysis

70 https://extremos.ffe.de/#what_if

2.2. Transport

Transport accounted for 25% of total EU+UK- greenhouse gas emission in 2018⁷¹, making it the second largest emitting sector and an essential component in the decarbonisation of the energy system. While the overall greenhouse gas emissions in the EU and in the UK have experienced a reduction over recent years, emissions from the transport sector have increased by 33% since 1990.⁷² In 2019 alone, the EU transport sector emissions, excluding shipping, increased by 0.8%.⁷² The transport sector can be decarbonised through a combination of low-carbon fuels, technology innovations, and behavioural changes. The difficulty of decarbonising transport varies per segment. Passenger cars and light-duty road vehicles, for instance, are easy to decarbonise by electrification due to their lighter load and shorter travel distances. Modes of transport that carry heavy loads and travel long distances with few opportunities for refuelling require fuels with high energy density and fast recharging times. Therefore these fuels are the most challenging to decarbonise.

This chapter describes the role for hydrogen in the transport sector. Hydrogen and hydrogen-derived fuels can be expected to play an essential role in the decarbonisation of the transport sector, especially in hard to electrify modes of transport, such as aviation and heavy-duty road transport. The following analysis builds upon the study 'Gas for Climate. The optimal role for gas in a net zero emissions energy system' published in 2019⁷³. The analysis examines the total hydrogen demand in aviation and heavy-duty road transport from 2020-2050 and finds a total direct hydrogen demand of 22 TWh in 2030, 140 TWh in 2040, and 285 TWh in 2050 (0 TWh, 9 TWh, 68 TWh of hydrogen demand from aviation and 22 TWh, 131 TWh, 217 TWh of hydrogen demand from heavy road transport in 2030, 2040, and 2050 respectively). The hydrogen demand for each relevant transport sector is determined at a country level for each country in the EU+UK. The data for total distance travelled per sector from 2020-2050 are from the IEA MoMo model⁷⁴. The decarbonisation pathways are based on company announcements, decarbonisation roadmaps, and stakeholder interviews. The following sections give an overview of the forecasts for road transport, aviation, and shipping⁷⁵ and decarbonisation pathways of heavy-duty road transport and aviation to 2050. The analysed sectors are assumed to be fully decarbonised by 2050.

2.2.1. Road transport

Key messages

- Hydrogen is a promising option to decarbonise heavy road transport, especially long-range vehicles, heavy road transport. Hydrogen fuel cells are forecasted to power 5%, 30%, and 55% of trucks and 4%, 21%, and 25% of buses in 2030, 2040, and 2050, respectively.
- The forecasted demand for direct hydrogen in heavy road transport in the EU+UK is 21 TWh, 131 TWh, and 217 TWh, accounting for 3%, 25%, and 58% of total heavy road transport energy demand in 2030, 2040, and 2050, respectively.
- Biomethane is expected to play an important transitional role in the decarbonisation of heavy road transport, with the majority of heavy road transport being powered by hydrogen and electricity in the long run. The decarbonisation pathway for heavy road transport implies that in the short-term, the gas grid will need to support the role out of a gas truck refuelling infrastructure to supply biomethane to trucks. Over time, as hydrogen trucks enter the fleet, the stations will need to convert to supplying both hydrogen and biomethane; the hydrogen infrastructure will need to be in place to supply these stations.

71 Eurostat (2020). Greenhouse gas emission statistics – emission inventories. https://ec.europa.eu/eurostat/statistics-explained/index.php?title=Greenhouse_gas_emission_statistics_-_emission_inventories#Trends_in_greenhouse_gas_emissions

72 European Environment Agency (2020). Greenhouse gas emissions from transport in Europe. <https://www.eea.europa.eu/data-and-maps/indicators/transport-emissions-of-greenhouse-gases-7/assessment>

73 Gas for Climate (2019). The optimal role for gas in a net-zero emissions energy system. <https://gasforclimate2050.eu/wp-content/uploads/2020/03/Navigator-Gas-for-Climate-The-optimal-role-for-gas-in-a-net-zero-emissions-energy-system-March-2019.pdf>

74 IEA (2021). The IEA Mobility Model. <https://www.iea.org/areas-of-work/programmes-and-partnerships/the-iea-mobility-model>

75 The decarbonisation pathway for shipping is assumed to follow the Gas for Climate 2019 study 'The optimal role for gas in a net-zero emissions energy system'. The study found that by 2050 all EU shipping would be powered by electricity or bio-LNG and therefore, the demand for hydrogen in the shipping sector is assumed to be zero. More information can be found in section 1.2.3.

Road transport is responsible for the majority of transport emissions in the EU. In 2017, road transport accounted for 72% of total EU transport greenhouse gas emissions (including international aviation and international shipping).⁷⁶ Decarbonisation of road transport is essential to achieving overall European climate goals. Electrification is a key component to the decarbonisation of road transport and will be deployed in all possible segments.

Decarbonisation options

Passenger cars and **light duty vehicles** that travel shorter distances and carry lighter loads are relatively easy to decarbonise through electrification. To decarbonise, the electrification of such vehicles is favourable due to the high efficiency of the electric motor and drivetrain. With increasing production volumes and declining battery costs, overall electric vehicles production costs are decreasing. Reduced costs, increased charging infrastructure, and improved battery technology will help to further increase the uptake of electric light-duty vehicles. Due to the benefits of the electric motor and the increasing penetration of electric vehicles in the global vehicle stock, by 2050, we assume the majority of passenger cars and light-duty vehicles to be battery electric. Hydrogen fuel cell passenger vehicles are currently available (i.e. Toyota Mirai, Hyundai Nexo, and Honda Clarity) and other car manufacturers have hydrogen incorporated in their company strategies (i.e. BMW, Jaguar Land Rover are currently developing hydrogen fuel cell vehicles). The short refuelling times and long driving ranges of hydrogen fuel cell passenger cars and light-duty vehicles can make them appealing for particular applications. However, as the vast majority of passenger cars and light-duty vehicles are forecasted to be battery electric, the analysis focuses purely on heavy road transport.

Although the decarbonisation of passenger vehicles is under way, the decarbonisation of heavy road transport still faces challenges. In 2018, heavy-duty vehicles were responsible for 27% of road transport CO₂ emissions and about 5% of total EU greenhouse gas emissions.⁷⁷ Road freight is deemed to be a particular difficult sector to decarbonise. Despite improvements in fuel consumption efficiency, the carbon dioxide emissions from heavy-duty vehicles have increased by 25% since 1990 and are still rising, resulting from the increase in road freight traffic.⁷⁷

Heavy-duty vehicles need to comply with the EU-wide CO₂ emission standards, adopted in 2019, to reduce CO₂ emission by 15% by 2025 and 30% by 2030.⁷⁸ Stricter emissions limitations will be implemented from 2030 onwards with the goal to achieve full decarbonisation by 2050. The regulation also incentivises the uptake of zero- and low-emission vehicles in a technology-neutral manner. These new, first-ever heavy road vehicle emission standards increase the need for zero-emission vehicles. Zero-emission vehicle technology has been a topic of conversation in the automotive industry, with companies like Renault beginning serial production of its electric truck and announcing that by 2025, 10% of its truck sales will be electric.⁷⁹ Europe's truck manufacturers have agreed that by 2040, all new trucks sold will need to be fossil-free in order to achieve carbon-neutrality by 2050.⁸⁰

Aside from technology and energy costs, the level of taxes, refuelling infrastructure, incentives, and consumer preferences will affect the future deployment of low- and zero-emission vehicles.⁸¹ Development of refuelling infrastructure is key to the penetration of different technologies. For zero-emission heavy road vehicles, four options exist:

- battery electric trucks,
- fuel cell trucks,
- biomethane (bio-CNG/bio-LNG) trucks, and
- electric road systems (i.e. catenary systems).

76 European Environmental Agency (2021). Greenhouse gas emissions from transport in Europe. <https://www.eea.europa.eu/data-and-maps/indicators/transport-emissions-of-greenhouse-gases/transport-emissions-of-greenhouse-gases-12>

77 European Environment Agency (2020). Carbon dioxide emissions from Europe's heavy-duty vehicles. <https://www.eea.europa.eu/themes/transport/heavy-duty-vehicles>

78 IEA (2019). Reducing CO₂ emissions from heavy duty vehicles. <https://www.iea.org/policies/8789-regulation-eu-20191242-reducing-co2-emissions-from-heavy-duty-vehicles>

79 Renault (2020). Renault trucks starts serial production of its electric trucks. <https://www.renault-trucks.com/en/newsroom/press-releases/renault-trucks-starts-serial-production-its-electric-trucks>

80 ACEA (2020). All new trucks sold must be fossil free by 2040, agree truck makers and climate researchers. <https://www.acea.be/press-releases/article/all-new-trucks-sold-must-be-fossil-free-by-2040-agree-truck-makers-and-clim>

81 Gilbert-d'Halluin, A; Harrison, P (2018). Trucking into a greener future. <https://europeanclimate.org/wp-content/uploads/2019/11/6-09-2019-trucking-into-a-greener-future-summary-report.pdf>

The decarbonisation of the heavy road transport sector is expected to utilise a combination of technologies, with green hydrogen playing a crucial role⁸². Battery electric vehicles are expected to play a larger role in the small and short-haul truck segments and fuel cells are expected to play a more prominent role in decarbonising the large long-haul truck segment.⁸³ As 56% of tonne-kilometre freight is covered by trucks traveling distances of ~300km or more⁸⁴, the majority of trucks need fast fuelling times and high-density fuels.

Liquid fuels (biofuels and hydrogen) will be important for the decarbonisation of heavy road transport, particularly heavy-duty long-distance trips. LNG is expected to play a transitional role with hydrogen, electricity, and bio-LNG being the energy sources for long-term decarbonisation. The fast refuelling times and high energy density make hydrogen and biomethane viable options for long-distance heavy road transport. However, by 2050, the majority of biomethane is expected to be used in other sectors where it has a higher societal value, such as in the heating of buildings and as an industrial feedstock.⁸⁵ As gas trucks are currently commercially available, biomethane can be used in the short to medium term to achieve emission reduction targets while zero emission alternatives (i.e. battery electric, hydrogen fuel cell) reach necessary scale.⁸⁶ Therefore, natural gas and biomethane can play a transitional role with some biomethane remaining in 2050, but to reach a decarbonised energy system in 2050, the majority of heavy road transport will be powered by hydrogen and electricity. The decarbonisation pathway for heavy road transport implies that the gas grid will need to support the roll out of a gas truck refuelling infrastructure to supply biomethane to trucks. Over time, as hydrogen trucks enter the fleet, the stations will need to convert to supplying both hydrogen and biomethane.⁸⁶

It is important to note that fuel cells used in fuel cell electric vehicles are highly sensitive to the hydrogen fuel quality. Impurities can cause significant issues for fuel cells, such as catalyst poisoning. Therefore, the hydrogen quality of the delivery system, including pipelines, would need to deliver hydrogen at fuel cell hydrogen purity levels or utilise purification technologies at the offtake of pipelines to allow direct utilisation of hydrogen. As most industrial or residential applications will not require fuel cell grade hydrogen, hydrogen purification and compression at the interface of the pipeline system and the fuel station distribution system may be a favourable option to reach the hydrogen fuel quality necessary for fuel cell applications.

Pathway towards 2050

By 2050, it is forecasted that a combination of technologies will be used to best satisfy various uses in heavy road transport.⁸⁷ Based on the Gas for Climate 2019 report⁸⁸, the new heavy road transport EU emission standards, and company statements, we assume that by 2050, 35% of heavy road freight will be electric, 55% will be powered by hydrogen, and 10% will be powered by biomethane. In addition, 75% of busing is assumed to be electric and 25% hydrogen fuel cell. Figure 11 below shows the energy demand pathway for heavy road transport from 2020 to 2050. In 2030, electricity accounts for 2% of the heavy road energy demand, hydrogen 3%, natural gas 29%, and diesel 66%. By 2050, electricity accounts for 28% of the heavy road energy demand, hydrogen 55%, biomethane 17%, and diesel 0%.

- 82 European Commission (2020). Heavy-duty vehicles CO₂ emissions: EU policy context. https://ec.europa.eu/jrc/sites/jrcsh/files/dg_clima_ze-hdv-jrc-webinar-2810020_public.pdf
- 83 ICCT (2020). Vision2050. https://theicct.org/sites/default/files/publications/ICCT_Vision2050_sept2020.pdf
- 84 ACEA (2011). Modal Shift Target for Freight Transport Above 300 km: An Assessment. https://www.acea.be/uploads/publications/SAG_17.pdf
- 85 Gas for Climate (2020). Gas decarbonisation pathways study. https://gasforclimate2050.eu/sdm_downloads/2020-gas-decarbonisation-pathways-study/
- 86 Element Energy (2021). The Future Role of Gas in Transport. <https://documents.cadentgas.com/view/957927673/10/>
- 87 Gilbert-d'Halluin, A; Harrison, P (2018). Trucking into a greener future. <https://europeanclimate.org/wp-content/uploads/2019/11/6-09-2019-trucking-into-a-greener-future-summary-report.pdf>
- 88 Gas for Climate (2019). The optimal role for gas in a net-zero emissions energy system. <https://gasforclimate2050.eu/wp-content/uploads/2020/03/Navigant-Gas-for-Climate-The-optimal-role-for-gas-in-a-net-zero-emissions-energy-system-March-2019.pdf>

FIGURE 11

Pathway of European energy demand in heavy road transport from 2020-2050

- Diesel
- (bio)-LNG/CNG
- Hydrogen
- Electricity

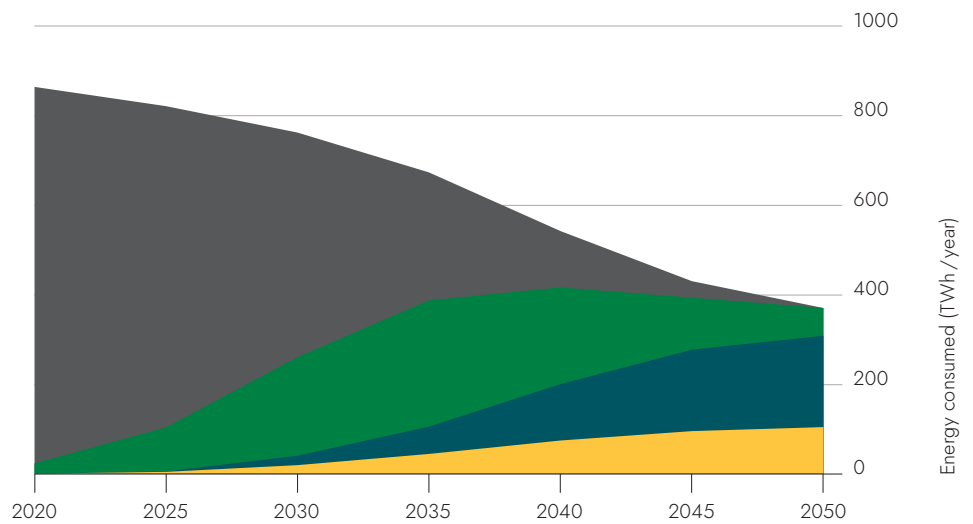

Source: Guidehouse analysis

In addition to the combination of technologies, Figure 11 shows that total energy demand for the heavy road transport sector in 2050 is forecasted to be approximately half of the energy demand in 2030, primarily due to improvements in fuel economy of heavy road vehicles. Battery electric and hydrogen fuel cell heavy duty vehicles are assumed to consume approximately 35% and 60% of the energy of a conventional diesel heavy duty vehicles, respectively. Therefore, the transition to these alternative vehicle technologies leads to a sustainable reduction in energy consumption. In addition, fuel economy improvements can result from a number of additional factors including improvements in heavy duty vehicle aerodynamics, engine mechanics, transmission technologies, and tires, weight reduction, and changes to driving behaviour. Also, a forecasted reduction in distance travelled by medium and heavy freight trucks until 2050 contributes to the reduced energy consumption.⁸⁹ Hydrogen demand in heavy road transport is 21 TWh in 2030, increasing to 131 TWh in 2040 and 217 TWh in 2050.

2.2.2. Aviation

Key Takeaways:

- Hydrogen and hydrogen-derived fuels are identified as promising options to decarbonise aviation. The largest source of hydrogen in aviation is anticipated to be from fuel production. Synthetic and bio kerosene are each forecast to power 7%, 33%, and 40% of aircrafts, equalling 50 TWh, 235 TWh, and 296 TWh of synthetic and 50 TWh, 235 TWh, and 296 TWh of bio kerosene in 2030, 2040, and 2050.⁹⁰
- Current research and development, company announcements, and policy indicate that hydrogen aircrafts can take to the air over the coming decades, with the potential of hydrogen powering short-range aircrafts. Hydrogen is forecasted to power 0%, 1%, and 10% of airplanes in the EU+UK in 2030, 2040, and 2050, respectively.
- The forecasted demand for direct hydrogen in aviation in the EU+UK is 0 TWh, 9 TWh, and 68 TWh, accounting for 0%, 1%, and 9% of total aviation energy demand in 2030, 2040, and 2050, respectively.

In 2017, direct emissions from aviation accounted for 3.8% of total CO₂ emissions in the EU.⁹¹ Aviation, responsible for 13.9% of transport GHG emissions, is the second largest source of transport emissions after road transport. Significant fuel efficiency improvements have been achieved in aviation over recent years. The fuel burned per passenger-kilometre dropped by 24% between 2005 and 2017.⁹¹ Despite fuel efficiency improvements, growth in air traffic has caused aviation's absolute CO₂ emissions to continue to rise. Aviation is a particularly difficult sector to decarbonise.

89 IEA (2020). The IEA Mobility Model. <https://www.iea.org/areas-of-work/programmes-and-partnerships/the-iaa-mobility-model>

90 Hydrogen demand to produce fuels are included in Industry in this report. Values and details of the hydrogen demand for fuels can be found in Section 2.1.4.

91 European Commission (2020). Reducing emissions from aviation. https://ec.europa.eu/clima/policies/transport/aviation_en

Decarbonisation options

There are two options for the decarbonisation of aviation, (1) sustainable aviation fuels (SAFs) (i.e. biofuels or synfuels) and (2) new propulsion technologies (i.e. battery- and turbo-electric technologies and electric motors powered by fuel cells). Over the coming decades, new propulsion technologies are expected to only play a role in short distance, regional and short-haul air transport due to the relatively low energy densities of hydrogen and batteries.

SAFs are expected to become a major contributor to the decarbonisation of aviation.⁹² Currently there is a discussion of an EU blending mandate of 2% sustainable aviation fuels in 2025 to 63% in 2050 to help cut aviation emissions.⁹³ SAFs can be drop-in fuels, benefiting from the use of existing aircraft engines and existing fuelling infrastructure at airports. The ease of drop-in fuels makes them an appealing and currently viable option to reduce emissions. SAFs are already in use and are expected to grow significantly over the coming decades. Since 2016, over 300,000 flights have used SAFs.⁹⁴ By 2050, we expect 80% of all aircrafts to be powered by SAFs, 10% to be hydrogen powered, and 10% to be battery electric. Given the difficulty to decarbonise, aviation is considered a priority sector for biomass feedstocks⁹⁵. Based on the Gas for Climate 2019 study, half of SAFs are expected to be bio-jet fuel and half are expected to be synthetic kerosene.⁹⁶ Therefore, since 80% of aircrafts in 2050 are forecasted to be powered by SAFs, bio-jet fuel and synthetic kerosene are each expected to power 40% of air travel in 2050.

Over the past couple of years, there has been increased interest and research and development into battery-electric and hydrogen fuel cell aircrafts. Small electric aircrafts up to 9 seats are already performing test flights, with regional aircrafts expected in the 2030s.⁹⁷ Interest in hydrogen aircrafts has increased dramatically over the past two years. Airbus has shifted their zero-emission aircraft focus from battery-electric to hydrogen and has released concepts for the world's first zero-emission commercial aircrafts. The three aircraft concepts are based on hydrogen as the primary power source and could enter service by 2035.⁹⁸ In addition, Airbus has recently stated that "hydrogen is increasingly considered as one of the most promising zero-emission technologies for future aircrafts".⁹⁹ An independent study, commissioned by the Clean Sky 2 and Fuel Cells and Hydrogen Joint Undertakings (FCHJU), found that hydrogen burned in a jet engine, used in fuel cells, or used to create synthetic liquid fuels could play a central role to the decarbonisation of aviation.¹⁰⁰

In the Destination 2050 report, five airline manufacturers, airlines, and airports developed a route to decarbonise European Aviation and identified that improvements to aircraft and engine technology and fleet replacement have the largest promise for decarbonising aviation in Europe in the 2050 timeframe.⁹² To decarbonise by 2050, the analysis includes the introduction of a hydrogen-powered single-aisle aircraft on intra-EU routes in 2035. The progression to zero-emission aircrafts is in line with the European Commission's goal to have a market-ready zero-emission aircraft by 2035.¹⁰¹ Due to the novelty of battery electric and hydrogen fuel cell aircrafts the penetration of both technologies is heavily dependent on technology advancements over the coming years. Electric powered aircrafts are not expected to significantly enter the aircraft fleet until 2035, and due to the long aircraft lifespans, they are expected to propagate slowly through the aviation fleet. The transition to battery-electric and hydrogen fuel cell aircrafts is heavily dependent upon technology advancements and governmental policy but is expected to play a role in aviation from 2035 onwards.

- 92 NLR – Royal Netherlands Aerospace Centre (2021). Destination 2050. https://www.destination2050.eu/wp-content/uploads/2021/02/Destination2050_Report.pdf
- 93 EURACTIV (2021). EU planning staggered increase in use of green jet fuel. <https://www.euractiv.com/section/alternative-renewable-fuels/news/eu-planning-staggered-increase-in-use-of-green-jet-fuel/>
- 94 IATA (2020). Developing Sustainable Aviation Fuels. <https://www.iata.org/en/programs/environment/sustainable-aviation-fuels/>
- 95 Gas for Climate (2020). Gas decarbonisation pathways study. https://gasforclimate2050.eu/sdm_downloads/2020-gas-decarbonisation-pathways-study/
- 96 Gas for Climate (2019). The optimal role for gas in a net-zero emissions energy system. <https://gasforclimate2050.eu/wp-content/uploads/2020/03/Navigant-Gas-for-Climate-The-optimal-role-for-gas-in-a-net-zero-emissions-energy-system-March-2019.pdf>
- 97 ATGA (2020). WayPoint 2050. https://aviationbenefits.org/media/167187/w2050_full.pdf
- 98 Airbus (2020). Airbus reveals new zero-emission concept aircraft. <https://www.airbus.com/newsroom/press-releases/en/2020/09/airbus-reveals-new-zeroemission-concept-aircraft.html>
- 99 Airbus (2020). Hydrogen in aviation: how close is it? <https://www.airbus.com/newsroom/stories/hydrogen-aviation-understanding-challenges-to-widespread-adoption.html>
- 100 FCH (2020). Hydrogen-powered aviation. https://www.fch.europa.eu/sites/default/files/FCH%20Docs/20200507_Hydrogen%20Powered%20Aviation%20report_FINAL%20web%20%28ID%208706035%29.pdf
- 101 European Commission (2020). Sustainable and Smart Mobility Strategy. <https://ec.europa.eu/transport/sites/transport/files/legislation/com20200789.pdf>

Pathway towards 2050

In the Gas for Climate 2019 study, energy demand in aviation in 2050 was estimated to be supplied by 50% bio jet fuel and 50% synthetic kerosene. Due to the increased development, research, and industry statements, our updated pathway includes battery-electric and hydrogen powered aircrafts. Both bio jet fuel and synthetic kerosene have their challenges in feedstock supply, resp. biomass and CO₂ from biogenic origin or from Direct Air Capture (DAC).

The updated air travel pathway in this report is composed of 10% battery electric, 10% hydrogen powered, 40% bio-jet fuel, and 40% synthetic kerosene in 2050. The new addition of battery electric and hydrogen powered aircrafts in the pathway compared to the Gas for Climate 2020 Pathways study is due to the increased research, developments, company announcements, and policy targets for a zero-emission aircraft in the 2035 timeframe in Europe. This leads to 68 TWh of direct hydrogen demand in aviation in 2050. However, the production of synthetic kerosene from hydrogen, as described in section 2.1.4 is still expected to represent the largest share of hydrogen demand in the aviation sector. The decarbonisation pathway for the aviation sector is shown in Figure 12 below.

FIGURE 12

Pathway of energy demand in aviation from 2020-2050 (in TWh)

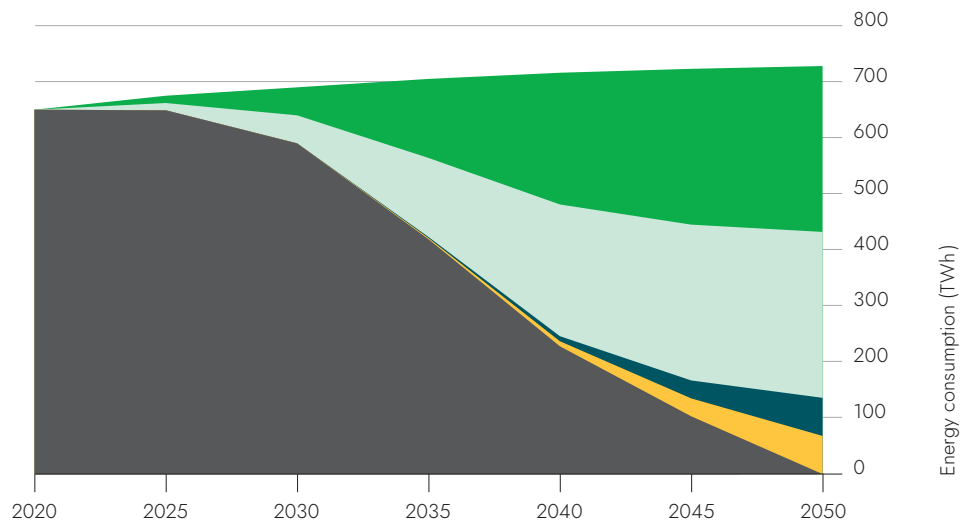
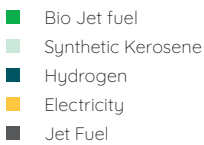

Source: Guidehouse analysis

Total air traffic is forecasted to nearly double over the coming decades, while at the same time, airplane efficiency is expected to improve by 1.5% per year.^{102, 103} These two opposing factors lead to a slight increase in total energy demand till 2050, as can be seen in Figure 12. The direct hydrogen demand in the aviation sector is 0 TWh in 2030, 9 TWh in 2040, and 68 TWh in 2050.¹⁰⁴

2.2.3. Shipping

In the Gas for Climate 2019 report, an analysis on the decarbonisation of the shipping sector was performed and found that by 2050, under the optimal gas scenario, domestic shipping is forecasted to be powered by 100% electricity, intra-EU by 50% electricity and 50% bio-LNG, and outbound EU by 100% bio-LNG. This analysis assumes the same shipping decarbonisation pathway as the Gas for Climate 2019 report and therefore forecasts no direct hydrogen or hydrogen derived fuels in the shipping sector.

102 IEA (2020). The IEA Mobility Model. <https://www.iea.org/areas-of-work/programmes-and-partnerships/the-iea-mobility-model>
IATA (2021).

103 Fuel Efficiency. <https://www.iata.org/en/programs/ops-infra/fuel/fuel-efficiency/>

104 Hydrogen demand for the production of SAFs is included in the Industry chapter in the Fuel Production subsection (2.1.4).

The full electrification of domestic shipping and half of intra-EU shipping is driven by electricity being the most cost-optimal shipping fuel due to its high efficiency. The forecasted uptake of electric ships is in line with the development and deployment of electric ships, with electric ships leading the transition of short-route ships in Europe. An example of this can be seen by Norway's electrification of its ferry sector. As of 2020, there are 450 battery-powered ships in operation or on order in Europe.¹⁰⁵ The low energy density of batteries limits electric ships to shorter routes and smaller ships.

The transition to bio-LNG in long distance, heavier shipping applications is based on a pathway that first transitions to LNG ships, followed by bio-LNG, as bio-LNG can be directly used in the gas engine and existing LNG infrastructure. Currently there are three commercially available engine and fuel systems for large bulk carrier ships: mono-fuel diesel engine running on Heavy Fuel Oil with a scrubber, a mono-fuel diesel engine running on Very Low Sulphur Fuel oil (VLSFO) or Marine Gasoil (MGO), and a dual-fuel LNG engine that can be powered by LNG or VLSFO/MGO.¹⁰⁵ LNG is the cleanest fossil fuel, has the necessary infrastructure in place, is available at scale, and generates no NO_x or SO_x emissions. With the EU promoting the introduction of LNG infrastructure in its ports, LNG ships meeting the IMO 2020 sulphur standards, LNG ships being currently commercially available, and the possibility of gas engines and LNG infrastructure being used for alternative fuels in the future, LNG is a possible transition fuel. As of January 2020, there were 175 LNG-powered sea-faring ships in service worldwide with another 200 LNG-powered ships on order.¹⁰⁶ As LNG does not contribute much to shipping decarbonisation, a switch to bio-LNG is anticipated. However, the transition to bio-LNG is a topic of discussion due to bioavailability and methane slippage.

Ammonia and methanol have been gaining favour in the shipping sector due to their potential zero carbon emissions, availability, and relatively high energy density compared to hydrogen and batteries. These fuels offer potential for the decarbonisation of the shipping sector, but the use of these alternative fuels needs further research and development to overcome technical and safety challenges.¹⁰⁷ The World Bank has identified "green fuels", including ammonia and hydrogen, as the most promising zero-emission shipping fuels and states that LNG is expected to play a limited role in the decarbonisation of shipping.¹⁰⁸ Currently, there is not a clear view on how the shipping sector will transition over the coming years. However, recent research, development, and company announcements into green fuels suggest that ammonia, methanol, and hydrogen will play a prominent role in the future shipping sector. We propose that the shipping analysis performed in the 2019 'Gas for Climate: The optimal role for gas in a net zero emissions energy system.' should be reviewed and updated over the coming years.

2.2.4. Transport conclusions

The demand for direct hydrogen in Europe in 2030, 2040, and 2050 is forecasted to be 21 TWh, 131 TWh, and 217 TWh, respectively for heavy road transport, approximately 3%, 25%, and 60% of the total heavy road energy demand and 0 TWh, 9 TWh, and 68 TWh for aviation, approximately 0%, 1%, and 9% of aviation energy demand. The hydrogen demand for the production of synthetic aviation fuels is covered in the Industry chapter of this report.¹⁰⁹

Hydrogen is expected to play an important role in the future transport sector. The extent of the role that hydrogen will play is dependent on the development of technology, infrastructure, and competitiveness of alternative fuels. Hydrogen and hydrogen-derived syngas are forecasted to account for 2% of the total energy demand in the transport sector in 2030, 13% in 2040, and 25% in 2050.

105 European Parliament (2020). Decarbonising maritime transport: The EU perspective. [https://www.europarl.europa.eu/RegData/etudes/BRIE/2020/659296/EPRS_BRI\(2020\)659296_EN.pdf](https://www.europarl.europa.eu/RegData/etudes/BRIE/2020/659296/EPRS_BRI(2020)659296_EN.pdf)

106 Port of Rotterdam (2020). LNG becoming increasingly popular in the shipping sector. <https://www.portofrotterdam.com/en/news-and-press-releases/lng-becoming-increasingly-popular-in-the-shipping-sector>

107 DNV GL (2020). Maritime Forecast to 2050. <https://eto.dnv.com/2020/Maritime/#maritime-top>

108 World Bank (2021). Charting a Course for Decarbonizing Maritime Transport. <https://www.worldbank.org/en/news/feature/2021/04/15/charting-a-course-for-decarbonizing-maritime-transport>

109 The hydrogen demand for synthetic aviation fuels is covered in the refinery section of the industry chapter (section 2.1.4). It is assumed that the production of synthetic fuels would take place at current day refinery locations and therefore, the hydrogen demand would be at these locations, not the locations of the fuel use. Only direct hydrogen use is considered in the transport section.

The country level breakdown of energy consumption in the aviation sector is based on historical values for per country yearly freight tonnage per kilometre¹¹⁰ for freight air travel and yearly total passengers carried for passenger air travel. The country level breakdown of the heavy road transport is based on historical per country heavy road transport vehicle stock.¹¹¹ Figure 13 shows the direct transport hydrogen demand for each country in the EU+UK for 2030, 2040, and 2050.

FIGURE 13

Direct hydrogen demand from the transport sector per country for 2030, 2040, and 2050 (in TWh)

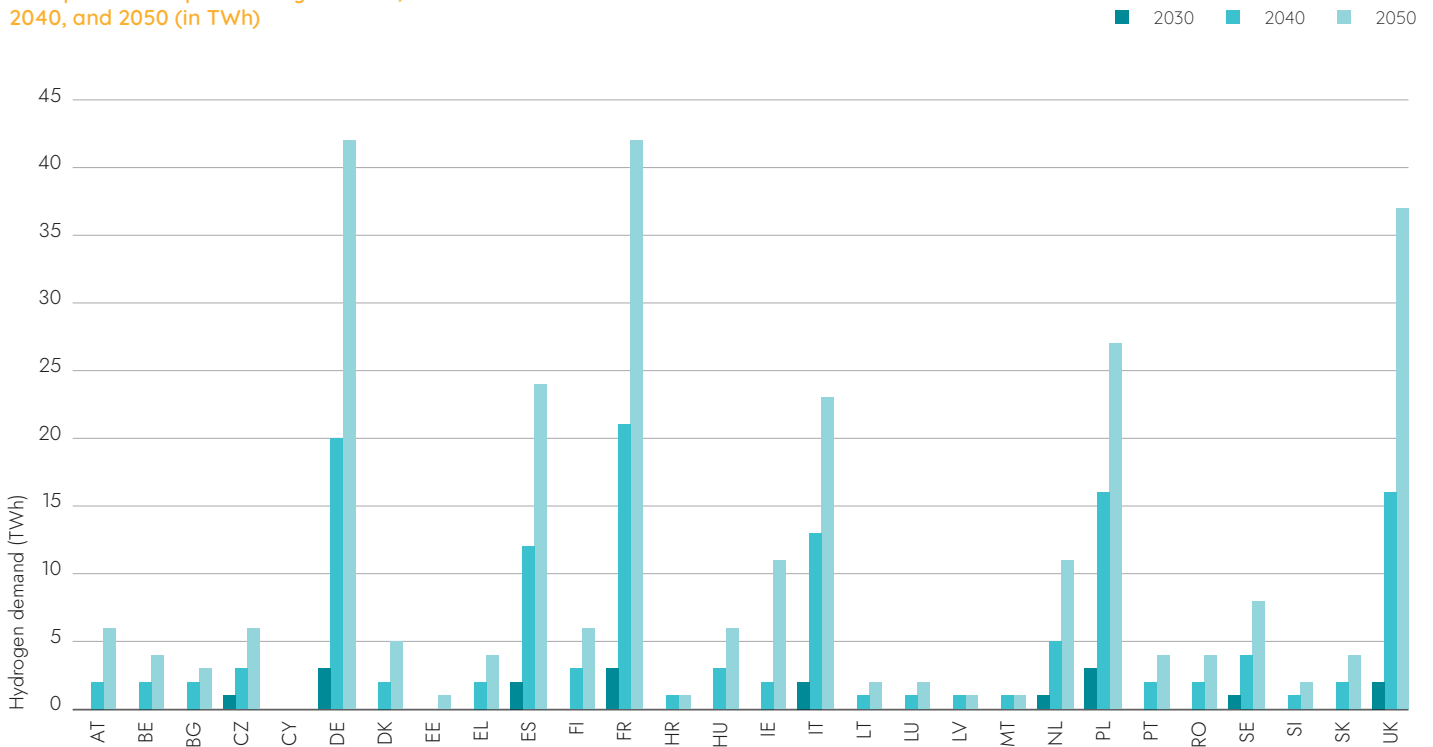

Hydrogen demand for synthetic fuels used in transport are not included in this graph.

Source: Guidehouse analysis

2.3. Power

“Harnessing the power of North Sea offshore wind requires us to look at the area as a whole, and to comprehensively rethink the energy systems of all of North-West Europe. This includes integrating different energy sectors and energy carriers. The European Hydrogen Backbone presents a valuable vision on the necessary complementary onshore hydrogen infrastructure.”

Michiel Müller, programme director
North Sea Wind Power Hub

The European power sector is rapidly evolving to achieve GHG emission reduction targets while providing a stable supply of electricity. Moreover, the demand for electric power is expected to further increase in the coming decades. The European GHG emission intensity for electricity generation was 45% lower in 2018 compared to 1990.¹¹² The reduction in GHG emissions largely stems from the increasing share of renewable produced electricity and the phase-out of coal fired power generation. Since 2015, renewable generated electricity has almost doubled while coal-fired electricity generation has been reduced by half.¹¹³ Renewable energy sources made up 38% of EU electricity consumption in 2020, up from 32% in 2018.¹¹⁴ In 2019, the wind capacity installed in the EU+UK was 185 GW and the solar capacity was 103 GW.¹¹⁴

In 2018, 21% of total European final energy demand was met with electricity.¹¹⁵ The electrification rate is expected to significantly increase over the coming decades in industry, transport, and buildings, taking advantage of the efficiency benefits of electricity use and the increasing supply of renewable generated electricity.

Variable renewable energy sources (wind and solar), are essential to decarbonise the power system and achieve GHG emission reduction targets. The increasing shares of wind and solar electricity, paired with the phase-out of fossil sources and partial nuclear power creates a challenge for balancing electricity supply and demand, requiring a highly integrated, smart energy system with storage to ensure security of supply. Hydrogen has the potential to provide large-scale and long-term storage of renewable energy and can balance loads in electricity networks. **This section explores the role of hydrogen in the European power sector and determines the country level power sector hydrogen demand for 2030, 2040, and 2050.**

Compared to the power generation mix today, the dispatchable power technologies in a highly electrified and renewable power system will need to cater for higher demand peaks and longer periods of under- and over-supply due to weather variations. Consequently, the average capacity factor of these plants will be low. This means **gas-fired units have two main advantages**: low cost per kW and high technical flexibility to follow residual loads. In the short-term, hydrogen can be blended with natural gas in gas-fired turbines. Over time, gas turbines can transition to being powered by 100% hydrogen. In addition, in the medium to long-term fuel cells can potentially also play a role in hydrogen powered electricity generation depending on cost of fuel cells.

The additional value of hydrogen over most other flexible power options is that it can be an **efficient and cost-effective means for storing large shares of energy over long periods of times** (i.e. seasons), in comparison to other options (i.e. batteries, interconnection, and demand response). Hydrogen can cost-effectively integrate and provide resilience to the highly-electrified net-zero power system (and economy) of the future. When integrated with the power system, it can provide long-term storage to manage the variation in power supply from wind and solar, reduce curtailment of fluctuating renewable energy sources, and provide grid balancing services. In addition, hydrogen can be used to transport renewable energy over long distances and as a feedstock in other industries, helping form an integrated energy system.

Stepwise approach is taken to determine the hydrogen demand on EU and bottom-down to the national level:

The future European electricity generation mix will be composed of high shares of wind and solar, hydro power, and some remaining nuclear power plants. Based on the Gas for Climate 2020 'Gas Decarbonisation pathways study', in 2030, the total electricity generation in the EU+UK is forecasted to be 3,700 TWh, 4,200 TWh in 2040, and 4,600 TWh in 2050¹¹⁶, excluding electricity generation for hydrogen production.

ENTSO's Network Development Plan TYNDP 2020 Scenario provides generation and capacity forecasts for each country in Europe for 2030 and 2040. Using the data from the Global Ambition scenario, generation per technology and per country in the power sector is forecasted for 2030, 2040, and 2050. The generation forecasts are scaled to total electricity generation from the Gas for Climate 2020 'Gas Decarbonisation pathways study' listed above and are used to determine the total amount of needed gas generation for 2030 and 2040. The analysis leads to a total gas generation in the EU+UK of 496 TWh in 2030 and 436 TWh in 2040. For 2050, the TYNDP 2030 and 2040 generation forecasts are smartly extrapolated to determine the needed gas generation in 2050, considering increases in renewables and each country's share of remaining dispatchable generators (nuclear, biomass, and hydro power). Therefore, the hydrogen demand per country is determined in relation to each country's nuclear, hydro power, biomass, solar, and wind forecasted generation quantities. The portion of

- 110 World Bank (2020). Air transport, freight. <https://data.worldbank.org/indicator/IS.AIR.PSGR?view=chart> <https://data.worldbank.org/indicator/IS.AIR.PSGR?view=chart>
- 111 European Commission (2017). Statistical pocketbook 2017. https://ec.europa.eu/transport/facts-fundings/statistics/pocketbook-2017_en
- 112 European Environment Agency (2020). Greenhouse gas emission intensity of electricity generation in Europe. <https://www.eea.europa.eu/data-and-maps/indicators/overview-of-the-electricity-production-3/assessment>
- 113 Agora (2021). Renewables overtake gas and coal in EU electricity generation. <https://www.agora-energiewende.de/en/press/news-archive/renewables-overtake-gas-and-coal-and-coal-in-eu-electricity-generation-1/>
- 114 Eurostat (2020). Electricity production capacities. https://ec.europa.eu/eurostat/databrowser/view/NRG_INF_EPC__custom_922715/default/table?lang=en
- 115 European Commission (2020). Share of energy products in total final energy consumption. <https://ec.europa.eu/eurostat/cache/infographs/energy/bloc-3a.html>
- 116 Gas for Climate (2020). Gas decarbonisation pathways study. https://gasforclimate2050.eu/sdm_downloads/2020-gas-decarbonisation-pathways-study/

hydrogen generation of the forecasted total gas generation is based on the Gas for Climate study, "Gas Decarbonisation Pathways 2020-2050" and is forecasted to be 1%, 35%, and 70% of the total gas generation in 2030, 2040, and 2050, respectively. A base assumption for the analysis is that electricity demand for green hydrogen generation for 2030-2050 is provided with dedicated renewables, i.e. the renewable generation sources used in the production of hydrogen are not connected to the power grid. Therefore, additional electricity generation is needed to produce green hydrogen.¹¹⁷

Extrapolated from the ENTSO's Ten-Year (TYNDP 2020 Scenario), we assume the EU electricity system in 2050 will be powered by 6% nuclear power and 84% renewable sources, out of which 15% solar, 50% wind, 13% hydro power, and 6% other renewables. This leaves 10% to be supplied using flexible, dispatchable generation technologies, including renewable gas turbines, and fuel cells.

To decarbonise the 10% of final European electricity demand, we assume that gas-based technologies can be decarbonised by using renewable or low-carbon gases, such as biomethane and hydrogen. Due to biomethane supply constraints and the high costs for carbon capture and sequestration at low capacity factors, hydrogen is expected to play a dominant role in the power sector. Biomethane is expected to be of higher value in other sectors, such as hard-to-electrify transport modes, in hybrid heat pumps for buildings, and as feedstock for specific industry applications (i.e. steel and ammonia production).

The analysis finds that the total European hydrogen demand¹¹⁸ in the power sector is 12 TWh in 2030, 301 TWh in 2040, and 626 TWh in 2050. with the hydrogen demand concentrated in Germany, Italy, Poland, and the United Kingdom. The country level hydrogen demand is shown in Figure 14 below.

- 117 Although it is not considered in this analysis, hydrogen production for use in other sectors can help integrate solar and wind generation. At times when the solar and wind generation exceed the electricity demand, the excess, cheap electricity can be used to produce hydrogen, minimising the curtailment of VRE and taking advantage of the low electricity prices. Hydrogen can help increase sector coupling and provide resilience to a highly electrified energy system.
- 118 Hydrogen demand in the power sector includes hydrogen used in gas fired turbines (both blended with natural gas and pure) and in fuel cells. In this analysis, we do not distinguish between the two, we assume hydrogen will be a percentage of final gas demand in the power sector and assume all gas to power applications have an efficiency of 50%.

FIGURE 14

Hydrogen demand for power sector generation in 2030, 2040, and 2050 per country

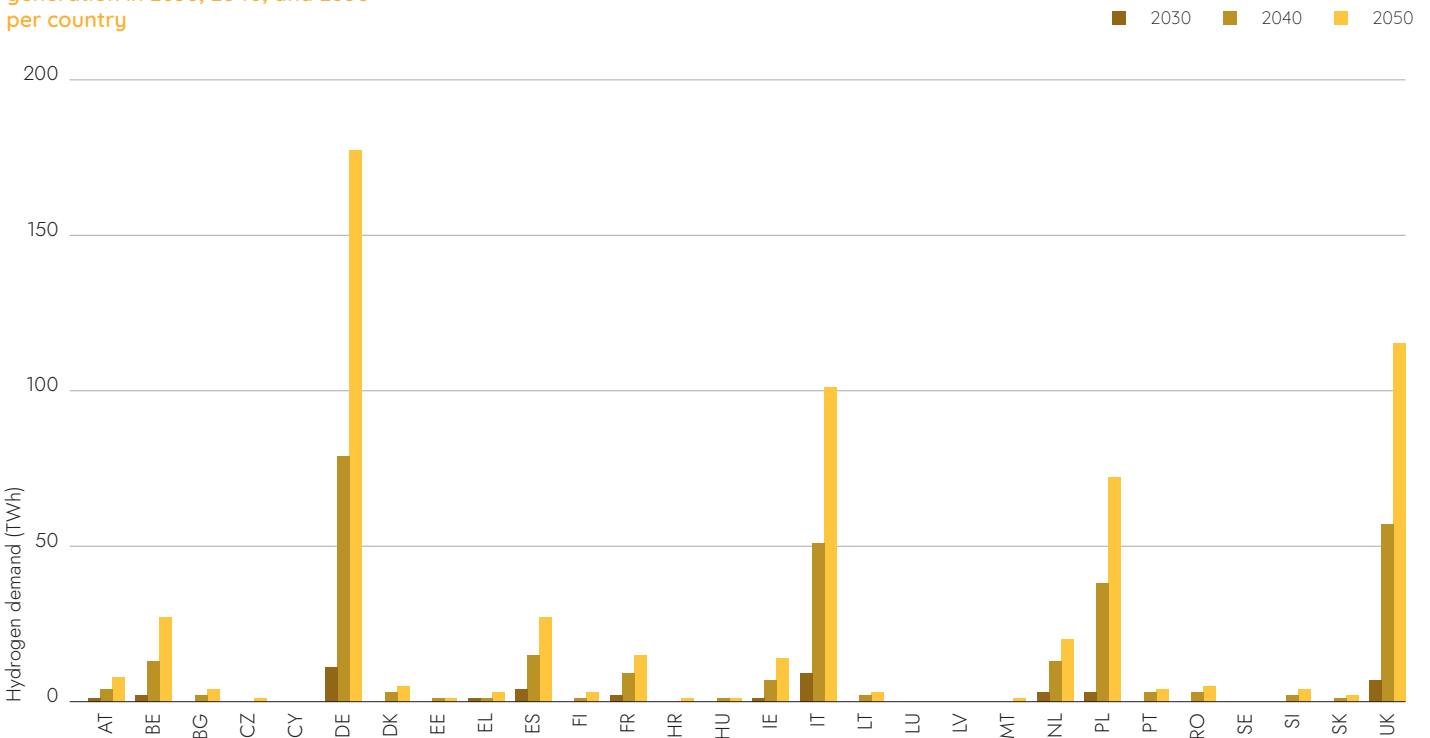

Source: Guidehouse analysis

Hydrogen-generated electricity is forecasted to account for 0.2% of the total European electricity generation in 2030, 4% in 2040, and 7% in 2050. Figure 15 provides a visual representation of hydrogen generated electricity of the total electricity generation per country in 2050. In 2050, hydrogen generated electricity is below 18% of total power generation for all countries in the EU+UK. As can be seen from the map, Poland has the greatest share of hydrogen produced electricity, with approximately 17% of the generated electricity coming from hydrogen.

FIGURE 15

Hydrogen generated electricity fraction of total country electricity generation in 2050 (in %)

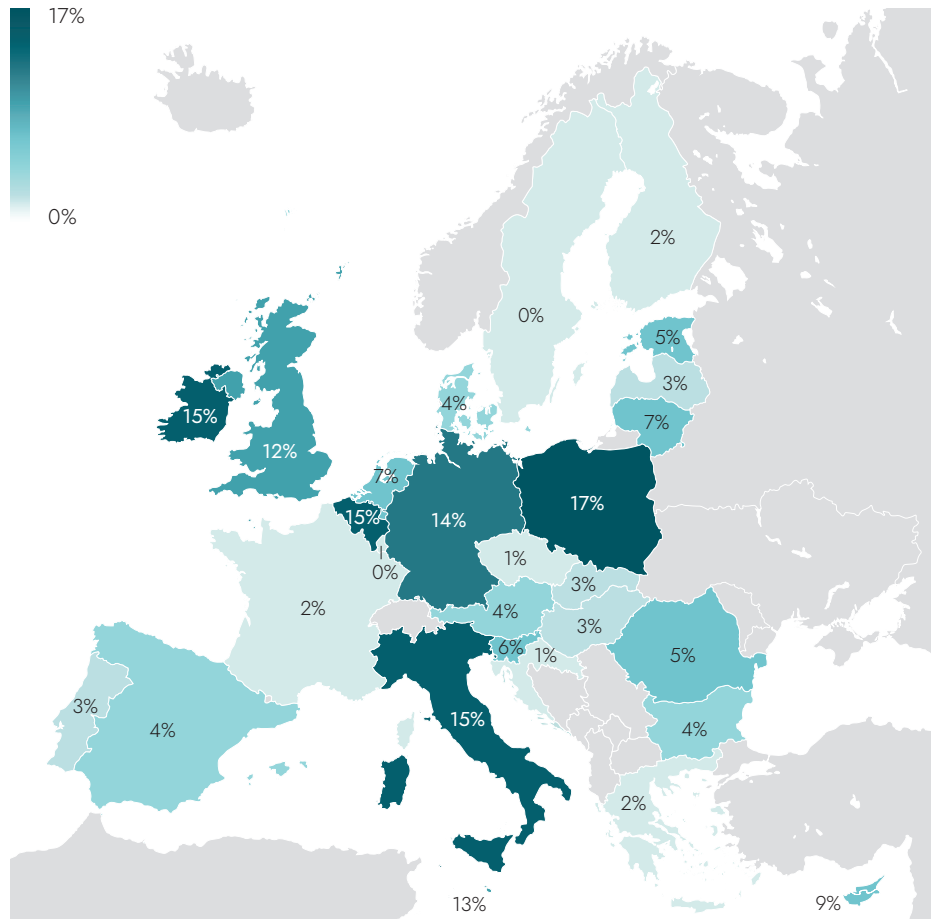

Countries with high shares of gas generation in TYNDP’s 2030 and 2040 generation forecasts (e.g. Belgium, Germany, Ireland, Italy, Poland and the UK) are forecasted to need relatively high shares of hydrogen. Hydrogen can be a replacement for existing natural-gas-fired power plants, providing the necessary dispatchable generation in a carbon-neutral manner. Natural-gas-fired turbines can be transitioned to hydrogen-fired gas turbines, utilizing existing infrastructure to cost-effectively decarbonise dispatchable generation. The countries with the highest share of gas demand in 2030 and 2040 in the TYNDP 2020 scenarios are Belgium, Germany, Ireland, Italy, Poland, and the United Kingdom. These are the six countries with the highest shares of hydrogen demand in 2050 in this analysis.

Countries with high shares of hydro-power-generated electricity are forecasted to have low needed shares of hydrogen-generated electricity due to hydro power’s storage capabilities and dispatchable nature. In addition, nuclear power, a baseload power plant, can help provide stable electricity supply. Therefore, countries with

forecasted remaining nuclear power in 2030, 2040, and 2050 are forecasted to typically need relatively lower dispatchable capacity, resulting in lower hydrogen demands, as can be seen in France, Bulgaria, Finland, and the Czech Republic. However, as can be seen in the case of the United Kingdom, remaining nuclear power does not necessarily indicate relatively lower shares of hydrogen demand, as hydrogen demand is dependent on numerous factors, including forecasted electricity generation from gas, solar, wind, hydro power, and biomass.

In the Gas for Climate 2020 Pathways study¹¹⁹ the 2050 hydrogen demand in the power sector was forecasted to be 786 TWh. The analysis was performed for all of Europe, using a single-node dispatch model. This current study finds a 2050 hydrogen demand in the power sector of 630 TWh resulting from lower forecasted gas generation compared to the Gas for Climate 2020 Pathways study¹¹⁹. The Gas for Climate 2020 Pathways study finds that 12% of total 2050 electricity demand would be supplied by renewable gases, whereas the current analysis finds that 10% of the 2050 electricity demand will be supplied by renewable gases. The main reason for this difference is that the previous Gas for Climate study performed an aggregated dispatch model for all of Europe. In comparison, to get country-level hydrogen values for 2030, 2040, and 2050 in the current analysis, extrapolations were performed using ENTSO's TYNDP 2020 Scenario¹²⁰. The different methodology can explain the difference between the two studies.

2.4. Buildings

Overall, buildings are responsible for about 40% of the EU's total energy consumption, and for 36% of its greenhouse gas emissions from energy.¹²¹ These figures refer to the use and operation of buildings, including indirect emissions in the power and heat sector.

The EU and UK together have over 300 million buildings, with a total floor space of 25 billion m², or 25,000 km². The vast majority (77%) of that floor space is in residential buildings, with the remaining 23% in use for all kinds of services, including offices, hospitals, shops, logistics, etc.¹²²

In general, reducing emissions from the heating of buildings will be a combination of reducing their heat demand by reducing heat losses through the building envelope (insulation) and through ventilation and reducing the emissions per unit of heat provided. The latter can e.g. be achieved by electric heat pumps using renewable electricity, by boilers using renewable or low-carbon gases, or by district heating using heat from renewable or low-carbon sources. The mix between insulation, installation and energy source will be determined by factors such as cost-effectiveness, acceptance, security of supply, and resilience. There will be variations in technology choices across different countries and regions due to significant differences both in terms of existing infrastructure as well as building stock and policy discussion.

Today, the buildings sector is the single largest natural gas using sector in the EU and UK, representing some 40% of overall natural gas consumption. Looking at the climate-neutral energy system by 2050, the Gas for Climate 2019 study concluded that it makes sense that all buildings with existing gas connections will continue to use gas in a cost-optimal climate-neutral energy system, albeit at significantly reduced volumes and with natural gas being replaced by biomethane and hydrogen. The Gas for Climate study concluded that hybrid heat pumps have an important role to play in buildings with an existing gas connection, and biomethane is in principle the preferred gas for their gas-fired boiler part, because it allows for an easy transition:

- No issues with distribution grid to the buildings (same molecule as natural gas)
- No new meters required
- Existing gas-fired boilers can be upgraded to hybrid heat pump, by adding a heat pump and a control

119 Gas for Climate (2020). Gas decarbonisation pathways study. https://gasforclimate2050.eu/sdm_downloads/2020-gas-decarbonisation-pathways-study/

120 TYNDP (2020). TYNDP 2020 Scenario Report. <https://2020.entsos-tyndp-scenarios.eu/>

121 European Commission, Communication 'A Renovation Wave for Europe'. https://ec.europa.eu/energy/sites/ener/files/eu_renovation_wave_strategy.pdf

122 <https://heatroadmap.eu/wp-content/uploads/2018/09/STRATEGO-WP2-Background-Report-4-Heat-Cold-Demands.pdf>, https://ec.europa.eu/energy/eu-buildings-datamapper_en

- No simultaneous change of gas required for entire housing district
- No new safety procedures, measures, and training required.

Starting points for new analysis

Since the publication of the Gas for Climate study, various stakeholders have shared feedback on this assumption and market development has progressed:

- Some (gas) DSOs see hydrogen as an option for heating of buildings, including 100% hydrogen boilers, e.g. in the UK (H₂1 North of England¹²³), the Netherlands (Stad aan 't Haringvliet¹²⁴), and Germany (H₂vorOrt¹²⁵). In some areas, a choice for hydrogen could mean that biomethane cannot be offered anymore.
- Regional biomethane availability may be an issue, e.g. in northern UK. Hence, hydrogen can be an alternative if the massive scale-up of biomethane does not materialise as foreseen in Gas for Climate.
- Policy makers often aim for a strong increase in renovation rates; the EC's Renovation Wave communication e.g. aims to "at least double the annual energy renovation rate of residential and non-residential buildings by 2030 and to foster deep energy renovations"¹²⁶. If the increase is less than policy makers assume, energy demand for heating will be higher than expected. This may subsequently lead to more demand for biomethane and hydrogen.
- Pure hydrogen boilers and fuel cells to supply heat and electricity have been developed and are increasingly available in the market today.

Decarbonisation options

In the future zero-emission energy supply of buildings in our scenario, hydrogen can play a role in three places:

- Hybrid heat pumps. As a renewable gas, biomethane has some advantages over hydrogen here, since its composition (methane) is the same as that of natural gas: no modifications are needed to the distribution grid and to gas meters, the current gas-fired boiler can become part of the future hybrid heat pump, and it is not necessary to change the homes and buildings in an entire district over to another gas at once. In an earlier Gas for Climate analysis, we assumed that 80% of the gas used in hybrid heat pumps could be biomethane requiring a substantial increase of current production. The role of green or blue hydrogen depends on the availability of biomethane within these assumptions, e.g. in regions with a limited availability of biomethane and/or where natural gas distribution grids would be converted to hydrogen distribution grids. Hydrogen-fired boilers are already available, and there are plans for 1-on-1 replacements of natural-gas-fired boilers as well; we have not considered that option here, because of the advantages of hybrid heat pumps in an energy system with high shares of variable renewables.¹²⁷
- District heating. In some countries, district heating is seen as an important part of the decarbonisation of buildings. Existing district heating systems, serving roughly 10% of the building floor space in EU+UK, often still run on heat from fossil fuel thermal power plants and industries. As the share of wind and solar in the power system grows, the capacity factors of thermal power plants will become low and changing industrial processes will not always produce the same amounts of heat as the current one either. So, the big challenge in district heating is finding renewable sources of heat for those (heat pumps, biomass, geothermal). Here, renewable and low-carbon gases can play a role too, and hydrogen does not have the disadvantages compared to biomethane that it has in heating individual homes: District heating systems have only one gas connection, so there are no

123 <https://www.h21.green/about/>

124 <https://www.installatie.nl/nieuws/miljoenen-voor-waterstofwoningen/>

125 <https://www.dvgw.de/themen/energiewende/wasserstoff-und-energiewende/h2vorort>

126 https://ec.europa.eu/energy/topics/energy-efficiency/energy-efficient-buildings/renovation-wave_en

127 Hybrid Heating Europe, vision paper (2021), Unlocking the hybrid heating potential in European buildings: <https://hybridheatingeurope.eu/?wpdmdl=2534>

issues with adapting many connections and meters, and changing over large numbers of homes at one moment. An efficient hydrogen-hybrid solution, applicable at all scales of district heating, would be a combination of:

- One or more electric heat pumps, to operate when (renewable) electricity is abundant and cheap and
- A hydrogen-fired CHP (gas engine or, in future, a fuel cell), to operate when (renewable) electricity is scarce and expensive)

This hybrid solution for district heating is mentioned by IEA as well¹²⁸. While the mix of renewable heat sources may vary by country, we have assumed a market share of 30% for such hybrid solutions for all countries, and within that a 50% share for hydrogen, and 50% for biomethane.

- Hydrogen-ready and pure Hydrogen Boilers. Hydrogen-ready boilers can operate on natural gas and, after a simple conversion, on hydrogen as well. They can be deployed in districts where it is expected that the gas in the distribution grid will be replaced by hydrogen within the lifetime of a boiler. In the application of hybrid heat pumps assumed in this study, this means that they could become part of a hydrogen hybrid heat pump once this replacement takes place. Pure hydrogen boilers can also be used as a 1-on-1 replacement of natural gas-fired boilers; this option is not part of our analysis, but it is considered in some countries.

Pathway towards 2050

In this study, we focus on transport of 100% hydrogen by gas infrastructure companies. Blending in combination with deblending of a limited volume percentage (5-20%), which is equivalent to 1.7-6.7% in terms of energy content and achievable emission reduction) can play a role in an early stage of the transition, e.g. to add scale to hydrogen supply volumes, but soon, higher CO₂ reductions will be demanded in the built environment. The -55% scenarios in the EC's Impact Assessment on Stepping up Europe's 2030 climate ambition¹²⁹ even show emissions reductions for residential buildings of 61.0-63.6% between 2015 and 2030.

Our analysis is based on data, follows a transparent approach, implying simplification, and treats countries as homogeneously as possible, with clear argumentation for possible differences. Given that in reality there are quite substantial differences between countries and regions, both in terms of existing infrastructure as well as building stock and policy discussion, working with ranges for demand is warranted to compensate to some extent the simplified model approach.

Evolution of the building stock

Data on the building stock and its energy situation is relatively scarce. There are over 300 million buildings in EU+UK, with an enormous diversity, and large differences between countries, in composition of the building stock, energy systems, and in reporting. Any analysis therefore needs a significant simplification. Table 1 shows the sources of the data that we have used for our analysis.

The building floor area per country over time is calculated as follows:

- Proportional to population growth, combined with,
- 1% annual growth of floor space (both residential and services) per inhabitant

From this, the new built floor area is derived adding in a demolition rate of 0.1% per year for residential floor space and 0.5% per year for non-residential floor space.

128 IEA, The Future of Hydrogen (2019), <https://www.iea.org/reports/the-future-of-hydrogen>

129 European Commission. Impact Assessment for Communication "Stepping up Europe's 2030 Climate Ambition" https://ec.europa.eu/clima/sites/clima/files/eu-climate-action/docs/impact_en.pdf

TABLE 1

Data and sources for residential and non-residential buildings

#	Data	Sources / calculations
1	EU + UK Building stock	Stratego (EU Project), Eurostat, Hotmaps (open source mapping and planning tool for heating and cooling)
2	Energy intensity, current fuel shares, technology mix	Hotmaps (www.hotmaps.eu)
2	Current renovation rates and impact on energy demand	Earlier Navigant / Guidehouse analysis for the European Commission
4	Population forecast 202-2050	Eurostat, UN
5	Building area forecast	Own calculation, based on population forecast and increase of area per inhabitant
6	New floor space area	Own calculation, derived from building area forecast and assumed demolition rate

A crucial factor in energy and emissions scenarios for buildings is the 'renovation rate'. In the Renovation Wave communication, the EC concluded that the current weighted annual energy renovation rate is low at around 1%. This estimate stems from a report by Ipsos and Navigant (now Guidehouse)¹³⁰, based on 30,000 consumer interviews and thousands of interviews of architects, contractors and installers. The impact of energy renovations on energy demand was calculated based on information on which measures were taken. Renovations were categorised in three bins:

- Light, with primary energy savings of 3-30%, current rate 4.1% of building stock each year
- Medium, with savings of 30-60%, current rate 1.4% per year
- Deep, with savings of 60% or more, current rate 0.2% per year.

In the Renovation Wave communication, the EC set the objective to "at least double the annual energy renovation rate of residential and non-residential buildings by 2030 and to foster deep energy renovations."

We modelled this by taking three renovation scenarios:

1. Renovation-as-usual: We keep the annual renovations as they are now, for the EU+UK: 4.1% for light, 1.4% for medium, and 0.2% for deep renovations.
2. Simple Doubled Renovation: we doubled the annual renovation rates across the board, taking the EU+UK weighted average to 8.2% for light, 2.8% for medium, and 0.4% for deep renovations.
3. Intensified Deep Renovation: We multiplied all current rates of deep renovations by 5, to achieve 1% per year, leaving the light and medium renovation rates at their current values, taking the EU+UK weighted average to 4.1% for light, 1.4% for medium, and 1.0% for deep renovations.

¹³⁰ Ipsos/Navigant. Comprehensive study of building energy renovation activities and the uptake of nearly zero-energy buildings in the EU (2019). https://ec.europa.eu/energy/sites/ener/files/documents/1.final_report.pdf

Both the Simple Doubled Renovation and the Intensified Deep Renovation increase the annual energy renovation rate (reduction of heat demand per m² of floor area) by approximately 45%. Given the current renovation rates, all buildings have undergone some renovation by 2050, but the number that has undergone a deep renovation by then is very limited under Renovation-as-usual (30 years at 0.2% = 6%) and even under the Simple Doubling scenario (12%). Only in the Intensified Deep Renovation Scenario, this reaches 30% of all building stock. This means that many buildings still have at best a moderate level of insulation, even by 2050, which keeps hybrid heating solutions relevant in the long run as well.

Both renovation scenarios will require a strong policy effort; so far, few successful examples exist of drastically increasing renovation rates at national scale. Such scenarios will highly depend on e.g. a sufficient number of craftsman to do the job, and the ability of homeowners to make the substantial investments required for deep renovations. We are disregarding those factors in our analysis but lower realised renovation rates will obviously correspond to a higher demand for biomethane and hydrogen.

Choice of heating technology and fuel

While renovation reduces heat demand and, as a consequence, final energy demand, latest by 2050, the energy to produce the heat will have to be zero-emission. In 2014, final EU+UK energy use for space and water heating was around 3,250 TWh/year¹³¹, out of which 44% (1,440 TWh/year) was natural gas.

The fuel mix for space heating only as a share of total useful floor space, according to the Hotmaps Project¹³², is given in Figure 16:

FIGURE 16

EU+UK fuel mix for space heating as a share of residential and commercial floor space year

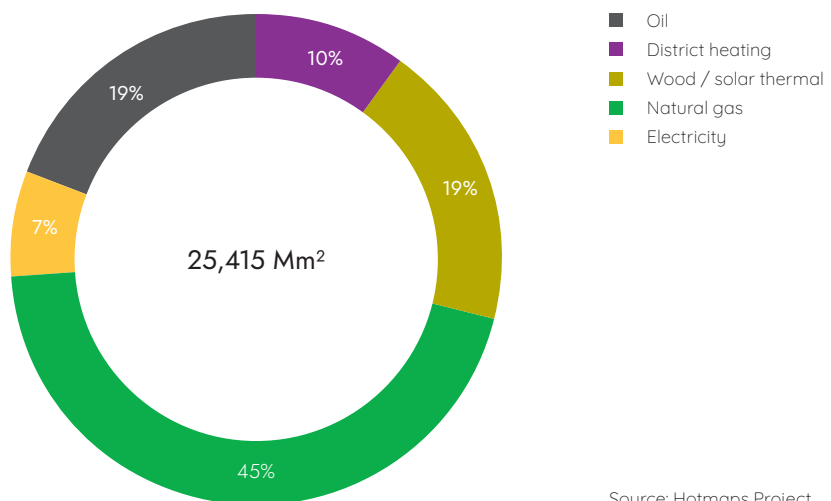

131 EU Buildings Database, https://ec.europa.eu/energy/eu-buildings-database_en

132 Hotmaps Project, D2.3 WP2 Report - Open Data Set for the EU28, 2018. Simon Pezzutto, Stefano Zambotti, Silvia Croce, Pietro Zambelli, Giulia Garegnani, Chiara Scaramuzzino, Ramón Pascual Pascuas, Alyona Zubaryeva, Franziska Haas, Dagmar Exner (EURAC), Andreas Müller (e-think), Michael Hartner (TUW), Tobias Fleiter, Anna-Lena Klingler, Matthias Kühnbach, Pia Manz, Simon Marwitz, Matthias Rehfeldt, Jan Steinbach, Eftim Popovski (Fraunhofer ISI) Reviewed by Lukas Kranzl, Sara Fritz (TUW). www.hotmaps-project.eu

In the current technology mix, condensing and non-condensing boilers dominate, using natural gas and oil as a fuel. Most of the electricity is still used in electric radiators, while wood (pellets) are used in stoves.

For this exploratory analysis of potential hydrogen demand in buildings, we have followed the reasoning in Gas for Climate reports that homes with a gas connection (currently using a gas-fired boiler) will over time switch to a hybrid heat pump. Pure hydrogen boilers, currently introduced to the market by manufacturers, and hydrogen fuel cells, with which experience has been gained in Japan, have not been taken into consideration, in view of the system benefits of hybrid heat pumps.

Our assumptions by current heating technology in existing buildings are the following:

- All existing buildings with district heating [DH] will keep that district heating but switch to zero-emission sources of heat.
- Buildings with gas-fired heating will get a hybrid heat pump, using biomethane or hydrogen in combination with electricity. The share of the heat demand provided by gas decreases with better insulation; for deeply renovated buildings, the biomethane or hydrogen will only provide peak demand. Hence demand is significantly reduced compared to a pure gas heating.
- All electrically heated buildings will get electric heat pumps [ASHP].
- Buildings now heated with oil will get a hybrid heat pump consisting of a combination of an oil-fired boiler and a heat pump; the reduced oil demand will be replaced by zero-emission liquid fuels over time.
- New buildings: 50% will get district heating, 50% an electric heat pump.

These assumptions are summarised in Table 2 below. In reality, more technology switches will of course happen, but in a time frame of 20-30 years a lot of infrastructure will also remain the same.

For the three renovation scenarios, we have calculated the development of the floor space that has undergone light, medium, and deep renovation, by the years 2030, 2040 and 2050, as defined above. The remainder was categorized as 'untouched'.

For the three renovation scenarios, we have calculated the development of the floor space that has undergone light, medium, and deep renovation, by the years 2030, 2040 and 2050, labelling the remainder as 'untouched'.

TABLE 2

Assumptions for replacement of existing building heating systems (rows) under the renovation levels achieved (columns) in a certain year

	Untouched	Shallow	Medium	Deep	New
District heating	Zero-emission DH	Zero-emission DH	Zero-emission DH	Zero-emission DH	n/a
Gas	Hybrid heat pump (G/E 70/30)	Hybrid heat pump (G/E 60/40)	Hybrid heat pump (G/E 40/60)	Hybrid heat pump (G/E 20/80)	n/a
Renewables	Renewables	Renewables	Renewables	Renewables	n/a
Electric	ASHP	ASHP	ASHP	ASHP	n/a
Other (oil)	Hybrid heat pump (oil/E 70/30)	Hybrid heat pump (oil/E 60/40)	Hybrid heat pump (oil/E 40/60)	Hybrid heat pump (oil/E 20/80)	n/a
New	n/a	n/a	n/a	n/a	50% district heating, 50% HP

DH = district heating, ASHP = Air-source heat pump, HP = heat pump

Subsequently, we have calculated the heat demand for the residential and services floor space, divided into the two categories where hydrogen can play a role (Hybrid Heat Pumps and District Heating) and a third category "Other", containing the floor space heated by all other solutions shown in Table 2. Overall, the heat demand per m² of floor space in the pre-2020 buildings is reduced by 25% in the Renovation-As-Usual scenario, and by 36% in both the Simple Doubled Renovation and Intensified Deep Renovation scenarios.

Finally, we have assessed the potential low-carbon and renewable gas development for hybrid heat pumps and district heating. It is assumed that hydrogen-based solutions are introduced gradually over time, given constraints on installation rates and hydrogen infrastructure. We have assumed that the following hydrogen shares can be realised, as a fraction of the total floor space where hydrogen can play a role:

- 2030: 5%
- 2040: 50%
- 2050: 100%

Under the Renovation-as-usual scenario in Figure 17, most of the pre-2020 building floor space only reaches light or medium renovation level even by 2050, while a small share of deeply renovated buildings and a larger amount of new buildings have a much lower heating demand. The increasing penetration of low-carbon and renewable gas the (potential) Hybrid Heat Pump and District Heating segments of residential and services buildings leads to a renewable gas demand of 790 TWh in EU and UK by 2050.

FIGURE 17
Results buildings sector in Renovation as usual scenario

- Floor space**
- New
 - Deep
 - Medium
 - light
 - Untouched

- Heat demand**
- Other, services
 - Gas boiler -> HHP, services
 - District heat, services
 - Other, residential
 - Gas boiler -> HHP, residential
 - District heat, residential

Other = Wood / solar thermal + electric + oil.
Next to hydrogen, this scenario results in 510 TWh of biomethane demand in buildings by 2050.

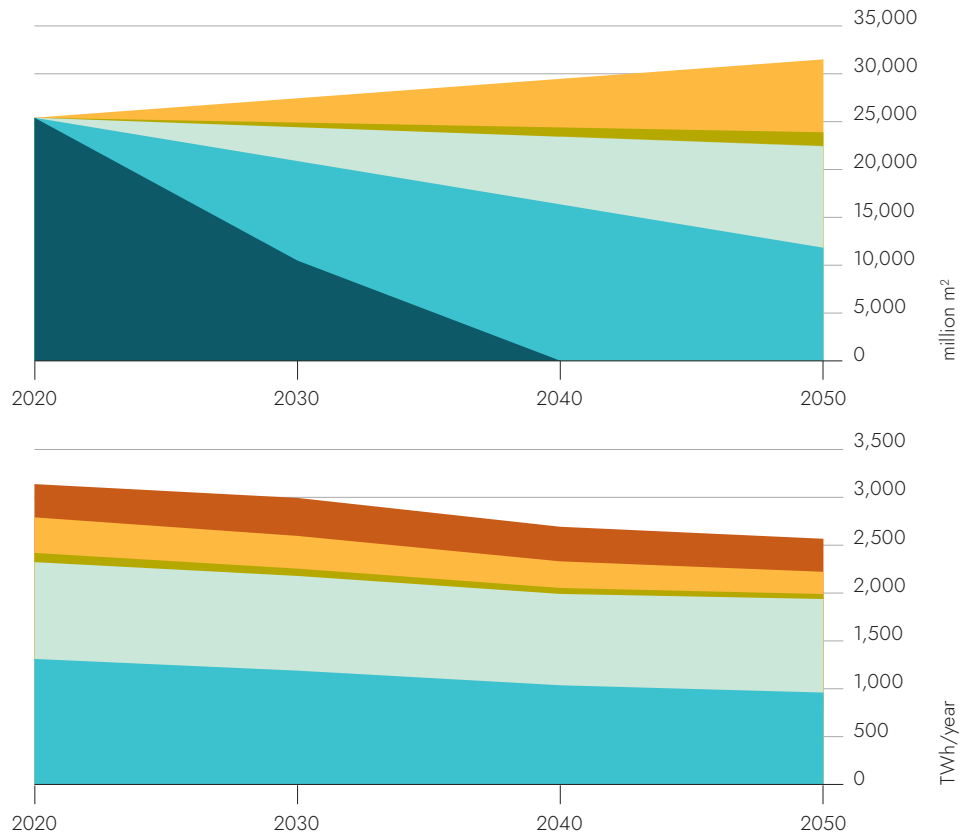

Source: Guidehouse analysis

Under the second, the Simple Doubled Renovation scenario in Figure 18, the dominant renovation grade of the pre-2020 building stock is Medium. While the addressable floor area is the same as in the Renovation-As-Usual scenario, the low-carbon and renewable gas demand in the building sector is reduced to 580 TWh by 2050.

FIGURE 18

Results buildings sector simple doubled renovation scenario

- Floor space**
- New
 - Deep
 - Medium
 - light
 - Untouched

- Heat demand**
- Other, services
 - Gas boiler -> HHP, services
 - District heat, services
 - Other, residential
 - Gas boiler -> HHP, residential
 - District heat, residential

Other = Wood / solar thermal + electric + oil.
 Next to hydrogen, this scenario results in 388 TWh of biomethane demand in buildings by 2050.

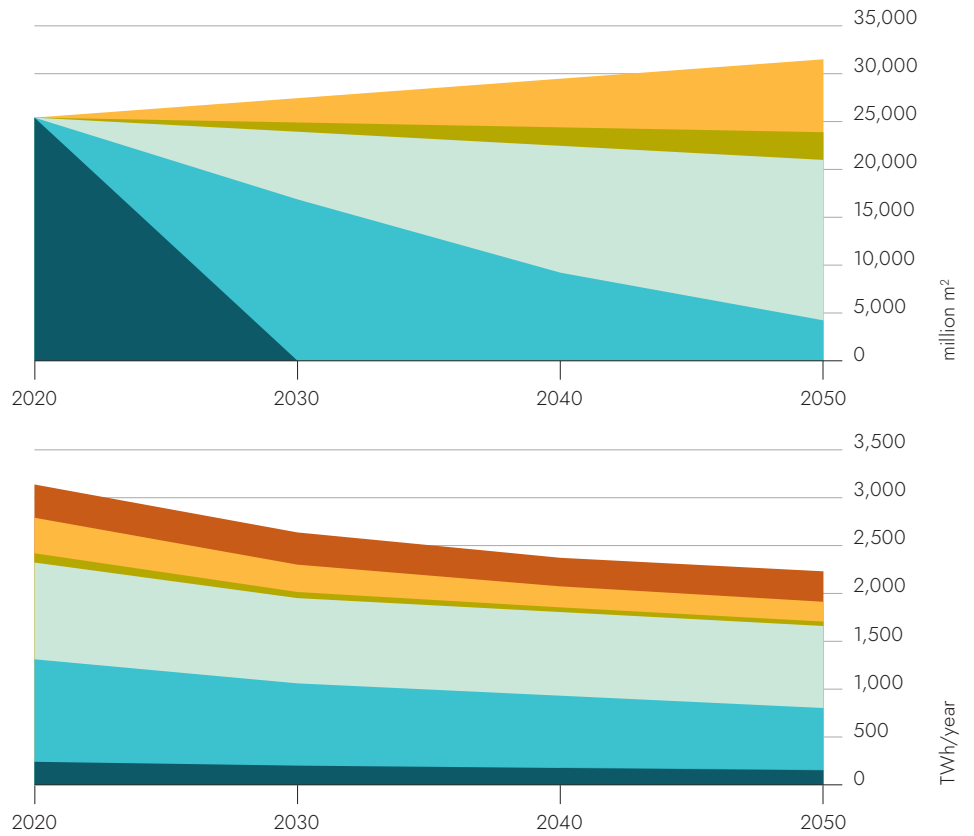

Source: Guidehouse analysis

Under the third, the Intensified Deep Renovation scenario in Figure 19, the share of deeply renovated buildings increases to around 20% of the remaining pre-2020 building floor area. In combination with light and medium renovation rates at their current levels, this leads to a low-carbon and renewable gas demand in buildings of 615 TWh/year by 2050.

FIGURE 19

Results buildings sector Intensified deep renovation scenario

- Floor space**
- New
 - Deep
 - Medium
 - light
 - Untouched

- Heat demand**
- Other, services
 - Gas boiler -> HHP, services
 - District heat, services
 - Other, residential
 - Gas boiler -> HHP, residential
 - District heat, residential

Other = Wood / solar thermal + electric + oil.
 Next to hydrogen, this scenario results in 407 TWh of biomethane demand in buildings by 2050.

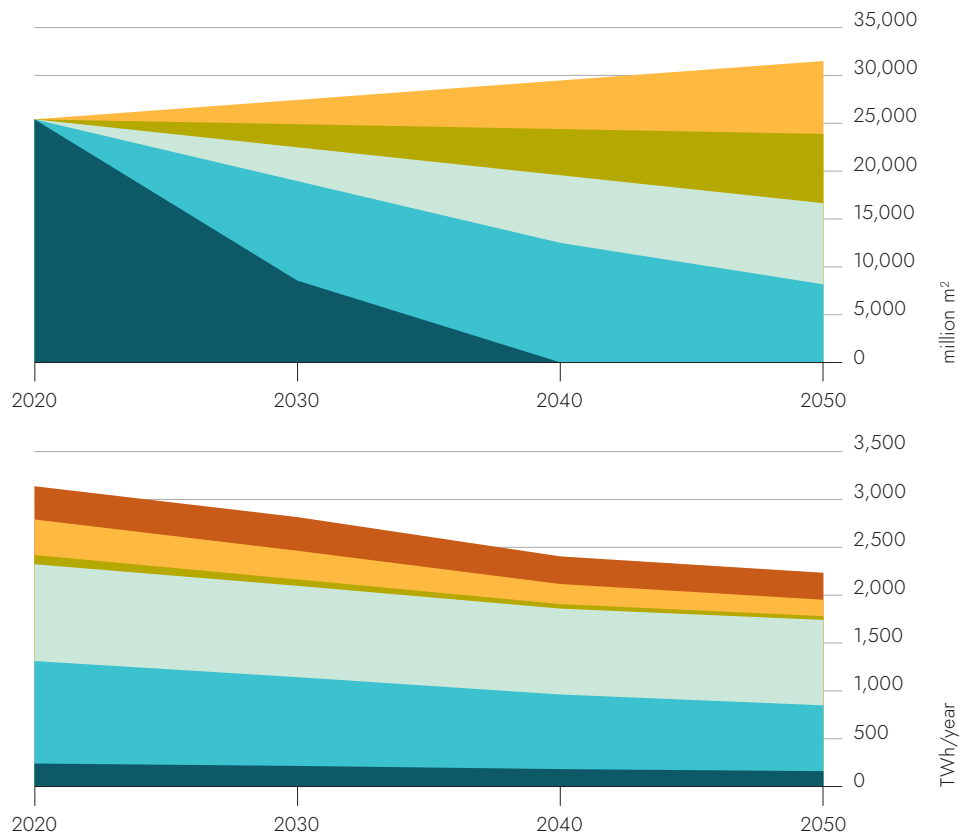

Source: Guidehouse analysis

The total demand for renewable and low-carbon gases in buildings is 580 TWh/year in Simple Doubled Renovation and 615 TWh/year in Intensified Deep Renovation, compared to—for reference—790 TWh/year in the Renovation-As-Usual scenario.

Whether or not this demand can be met with biomethane depends on a successful scale-up and its regional availability. In the optimistic case, based on a prior Gas for Climate study wherein biomethane supply was estimated at 1,170 TWh/year, this study assumes that biomethane could be available to supply 80% of that demand, as shown in Figure 20 below.

FIGURE 20

Hydrogen and renewable and low-carbon gas demand for heating of buildings in EU and UK (in TWh/year)

■ Hydrogen demand estimate in this study
■ Total renewable and low-carbon gas demand

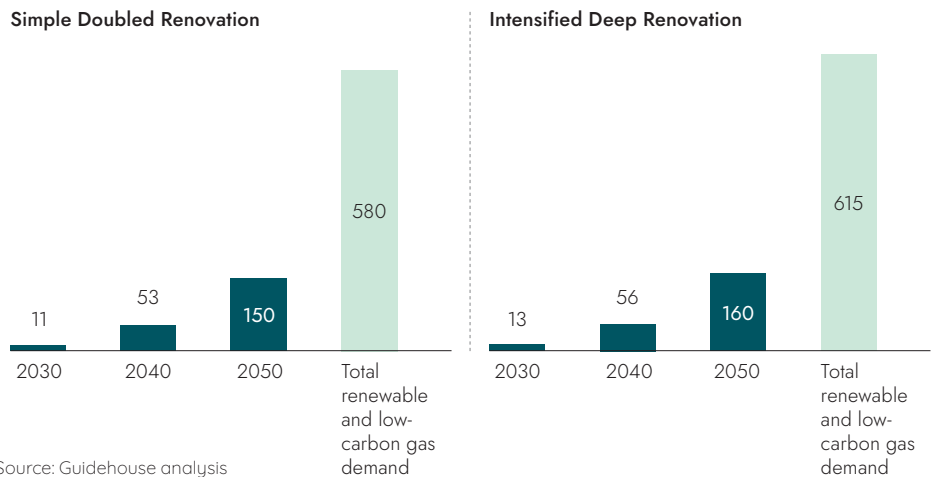

Source: Guidehouse analysis

In case these biomethane potentials do not materialise or in the event very competitive hydrogen supplies were available, hydrogen could be used to meet a bigger share of this demand. This results in a range for the hydrogen demand in buildings reaching from 0 to around 600 TWh/year depending on the achievable renovation rate and developments of future renewable and low-carbon gas. In reality the split between hydrogen and biomethane will vary significantly by region – with hydrogen likely taking up a more substantial share of demand in countries such as the UK, Germany, and Luxembourg – where biomethane constraints are more prominent and where discussions regarding the role of hydrogen in the buildings sector are more prominent.

Sensitivity

The buildings sector has hundreds of millions of decision makers, and – as mentioned above - a big diversity both between countries (climate, energy infrastructure, policy) and within them (urban/rural areas, multi/single family homes, wide variety of non-residential building uses). Applying a more or less homogeneous approach, as attempted in this section is necessary to gain overall insights, but also challenging because of this complexity.

When looking at the choices made here, those with the biggest impact on the outcome are:

- Applying hybrid heat pumps to all existing buildings with a gas connection. The advantages of this solution to the energy system, by ‘system integration behind the meter’, are large, which should in the end also result in a cost advantage for building users. However, in reality, other solutions will be chosen as well. For example, in Germany, the UK, and Czech Republic, hydrogen boilers, fuel cells, and micro-CHP plants are currently being considered for decarbonizing buildings at very low costs (assuming a high availability of competitively priced hydrogen).

- Assuming a high share of biomethane (80%) as the gas of choice for hybrid heat pumps, and a medium share of biomethane (50%) in renewable gas-fired CHPs used for district heating. Development of sustainable biomethane supply is still in its early stages, and most biogas is so far used in decentral cogeneration plants. The easier transition from natural gas to biomethane makes the latter well-positioned to speed up renewable and low-carbon gas volumes, but where biomethane supply does not materialize, hydrogen can take a bigger share.
- The renovation rate. Here we have assumed that policies like the EU Renovation Wave and national equivalents achieve their goals of significantly accelerating energy renovations. If this does not fully materialize, the demand for hydrogen in buildings may go up moderately.

In specific regions or countries, the impact of other choices and developments may be very large. If e.g. in the UK, the choice is made to use hydrogen boilers instead of hybrid heat pumps, and a strong increase in energy renovations is discarded, the resulting hydrogen demand in buildings can be as much as a factor of 10 higher than estimated here.

Overall, the existing gas grid, with its high capacity, and its ability to transition from carrying natural gas to biomethane (gradually) and hydrogen (stepwise, after a potential initial blending/deblending phase), can act as safety net and turns out to be the most cost-optimal solution in the energy transition of the built environment. The challenges connected to the full decarbonisation of buildings, which sees in the deep renovation rate a hard-to-solve barrier which goes well beyond just achieving energy savings and lowering the thermal consumption, may find in a combination of biomethane and hydrogen heating technologies the potential solution to overcome the aforementioned barriers. Technological developments will play a key role in driving the degree of adoption of the different options. Both at longer time scales, e.g. if it turns out to be costly and hard to achieve the desired acceleration in building renovation, and at short time scales, e.g. by temporarily shifting electricity use to the use of renewable and low-carbon gases, during ‘windless winter weeks’.

2.5. Conclusions on hydrogen demand

For the **decarbonisation of industry**, hydrogen will be a crucial feedstock in multiple sectors. It is particularly relevant for ammonia, high value chemicals (HVC), iron and steel, and bio and synthetic kerosene production, where electrification is not an option. In these sectors, hydrogen is primarily used as feedstock, while in industrial heat hydrogen demand is forecasted for mostly high temperature processes. The bottom-up pathways for industry, enabling NUTS 2 level granularity of the demand estimations, are informed by company announcements, sector decarbonisation roadmaps and interviews with relevant stakeholders. This analysis therefore assumes a scenario where industry does not relocate within or outside of Europe. Instead, the European Hydrogen Backbone enables the required transport of large amounts of clean energy in the form of hydrogen to the current industrial locations.

In the **transport sector** electrification, where possible, is a promising option for a range of transport modes, but there is still a clear role for hydrogen with a demand of about 300 TWh of hydrogen as a fuel in heavy-duty trucking and aviation, by 2050. Hydrogen-derived carriers such as synthetic kerosene will play an important role in decarbonising the aviation as well.

A quantity of approximately 650 TWh of hydrogen can be expected in **dispatchable electricity production** in 2050, in a system with large shares of wind and solar. The value of hydrogen, over most other flexible power options such as batteries and demand response, is that it can be supplied and stored in large quantities at relatively low investment costs, making it particularly appealing for longer duration storage.

Heating in buildings will be decarbonised using a range of technologies with significant regional variations. The hydrogen demand depends on renovation rates, the relative shares of biomethane and hydrogen, and the mix of heating technologies. This study assumes Europe-wide accelerated renovation rates and hybrid heating systems in existing homes with a gas connection and in 30% of district heating. Such hybrid systems use electricity (in a heat pump) and renewable or low-carbon gas. This approach reduces energy system costs, enabling lower cost to consumers and faster emission reduction. As the hybrid heating systems mainly use gas as peak energy supply, gas demand is lower than in gas-only solutions like hydrogen boilers and fuel cells considered in other studies. Under this study's assumptions, annual renewable and low-carbon gas demand in buildings will be around 600 TWh in 2050. All of this could be hydrogen, yet assuming a scale-up of biomethane as in previous Gas for Climate studies, annual hydrogen demand would be around 150 TWh.

Expected EU+UK hydrogen demand by 2050 equals 2,300 TWh, consisting of 1,200 TWh in industry, 300 TWh in heavy transport, 650 TWh in power, and 150 TWh in buildings. Figure 21 below shows how these 2050 demand figures compare with results from other recent EU decarbonisation studies. Note that this study categorises hydrogen demand for synfuels under 'Industry (feedstock & energy)', rather than under transport as is done in the other scenarios.

FIGURE 21

Four scenarios on green and blue hydrogen demand by 2050 according to recent EU decarbonisation studies

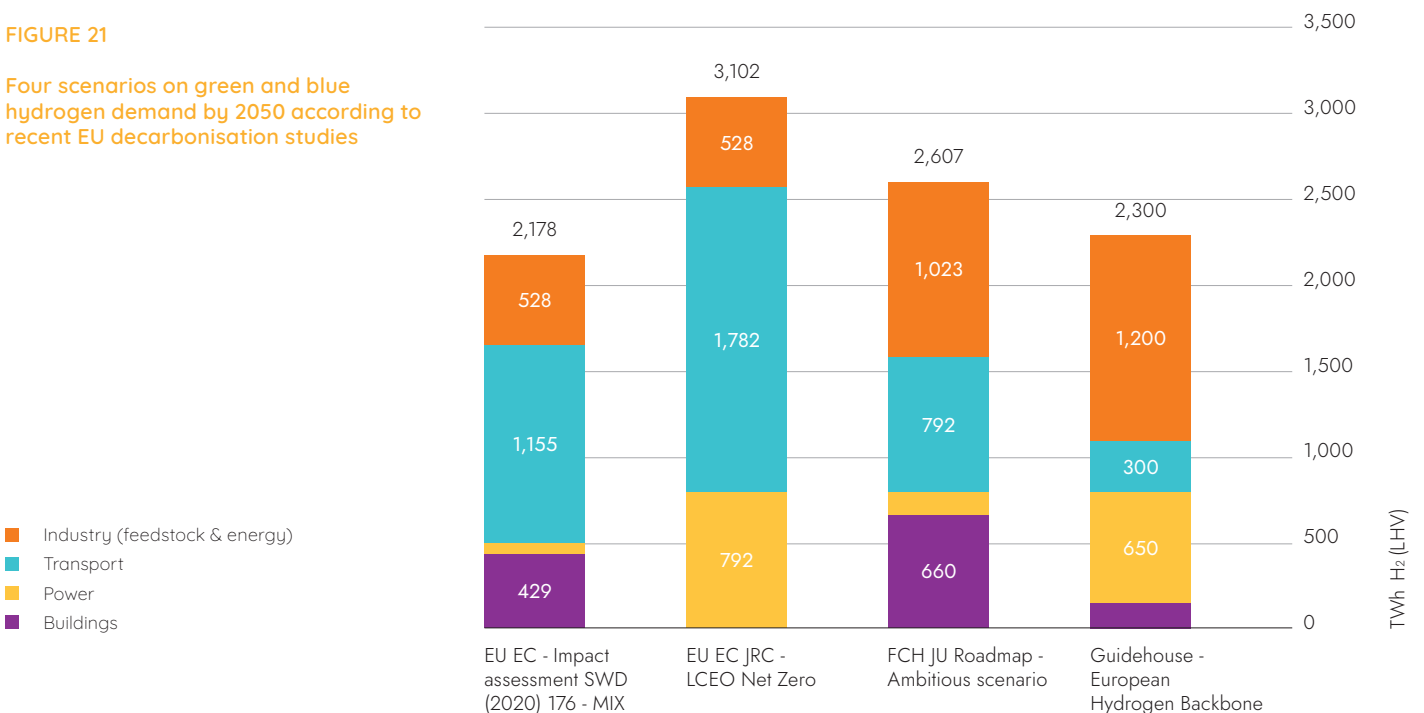

Note that this study (Guidehouse - European Hydrogen Backbone) categorises hydrogen demand for synfuels under 'Industry (feedstock & energy)' rather than under transport, as is done in the other scenarios.

3. Hydrogen Supply

Key messages

- Domestic green hydrogen supply potential in the EU and UK from dedicated renewables—considering the needs of the electricity market, land availability, environmental regulations, and installation rates—is estimated to be 450 TWh in 2030, 2,100 TWh in 2040, and 4,000 TWh in 2050. This potential already takes into account the growing need for renewable electricity for direct consumption, land availability, environmental considerations and installation rates. Realising this potential will likely require a rapid, vast expansion of wind and solar capacity, beyond what is needed for direct electricity demand and corresponding to cumulative installed capacities of 1,900 GW in 2030, 3,200 GW in 2040, and 4,500 GW in 2050. The 2030 installed capacity figure represents a more than doubling of current cumulative National Energy and Climate Plan targets.
- From 2040, there can be sufficient green hydrogen supply available in Europe, subject to public acceptance of an accelerated deployment of renewable installed capacities, to meet projected European hydrogen demand in all sectors at lower cost levels compared to grey hydrogen and other fossil alternatives plus the CO₂ price. By 2050, almost all of the potential 4,000 TWh of green hydrogen can be produced for less than 2.0 €/kg, of which up to 2,500 TWh can be produced below 1.5 €/kg and around 600 TWh can be produced at 1.0 €/kg. Supplying the entire projected 2,150-2,750 TWh hydrogen demand in 2050 using domestic EU and UK renewables would require around 2,900-3,800 TWh of dedicated renewable electricity. However, producing such quantities of green hydrogen within the EU and UK is subject to public acceptance of an accelerated expansion of renewable installed capacity even beyond currently planned expansion.
- Europe also has a large potential to produce blue hydrogen. Supply is virtually unlimited as natural gas supply and CO₂- storage potential exceed the total foreseen hydrogen demand. Blue hydrogen production costs are expected to be 1.4-2.0 €/kg at moderate natural gas and CO₂-prices¹, but could rise up to 1.6-2.3 €/kg during the 2030s and 2040s when CO₂-prices further increase. Natural gas producing countries could benefit from lower natural gas costs to produce blue hydrogen at 1.0 €/kg. Blue hydrogen can quickly drive emission reductions and accelerate the pace of the transition, especially in the market's ramp-up phase (2030), when green hydrogen supply potential from dedicated renewables alone will be insufficient to meet local and regional demand in absence of a fully interconnected European hydrogen backbone. Although EU and UK greenfield and brownfield blue hydrogen supply potential is almost unlimited, projects announced to date add up to 230 TWh by 2030 and 380 TWh by 2035 and onwards – with 70% of announced project volumes stemming from the UK and the Netherlands.
- Beyond 2030, deployment of new blue hydrogen projects will face increasing competition from green hydrogen (domestic and import), as this becomes more widely available at lower costs. However, there will still be a role for (by then) existing blue hydrogen projects—which have a lifespan of 25 years—to continue producing as the marginal supply option and to contribute to system integration and balancing of variable green hydrogen through firm, baseload hydrogen production.
- In addition to domestic EU and UK supply, abundant natural resources and physical proximity drive the favourable economics of pipeline imports from neighbouring regions such as North Africa and Ukraine, making these regions attractive partners for future hydrogen trade. In the near-term, pipeline imports will remain modest as these neighbouring regions focus on electrifying and meeting the needs of their own growing economies. By 2040 and 2050, pipeline imports become increasingly attractive, with estimated long-distance pipeline transport costs of 0.09-0.16 €/kg/1000km for 48-inch pipelines, which only weigh marginally on the final delivery cost of hydrogen when considering production costs of 1.0 €/kg or less.

3.1. Introduction

Different EU+UK decarbonisation scenarios conclude that renewable and blue hydrogen demand will grow significantly. The studies¹³³ in which these scenarios are reported generally agree that expected volumes of hydrogen could technically be produced within the EU but point out that this would mean a substantial acceleration in the deployment of additional wind and solar PV capacity. The further development of an integrated, liquid, and competitive hydrogen market requires a better understanding of the installed capacities of wind and solar needed for green hydrogen as well as potential capacities of blue hydrogen production, with an indication of the parts of Europe where new capacities could be built. In addition, there remains a question around the extent to which hydrogen imports can play a role in complementing domestic, EU+UK hydrogen production.

This Chapter aims at presenting well-founded figures on the installed capacities and costs of renewable and blue hydrogen required to implement Europe's decarbonisation ambitions. Sections [3.2] and [3.3] assess the European supply potential and production cost of green and blue hydrogen, respectively. Section [3.4] provides an overview on the potential role of hydrogen imports, with an emphasis on Ukraine and North Africa, two regions identified as strategic partners by the EC.

3.2. Green Hydrogen

“There will be enough electrolyser manufacturing capacity to meet European demand. ITM Power is ready to facilitate the scale up of hydrogen. Our new gigafactory has a production capacity of 1 GW electrolysers per year and we raised capital to build a second Gigafactory to increase annual capacity to 2.5GW per year.”

Dr. Graham Cooley
Chief Executive Officer
ITM Power

When it comes to assessing the supply potential of green hydrogen—and by extension, renewable energy—many studies start from the perspective of demand. The question is often framed in the form of: “given a certain volume of expected future demand, what would be the most practical and cost-effective way to supply it, considering the supply options available?”. However, by constraining supply requirements and solutions to best estimates of demand and existing supply technologies, demand-driven approaches could miss important insights and possibly underestimate the impact of new technological and commercial innovations on the supply side.

a fully decarbonised power grid. In this case, green hydrogen supply would be constrained by practical issues related to connecting renewable energy projects to the power grid today, such as interconnection limits, permitting constraints, and power grid congestion. In systems where a high share of wind and solar supplies the electricity, hydrogen produced in periods of oversupply can be used to generate dispatchable power in days and weeks with undersupply, as has been demonstrated by modelling for 180 GW of offshore wind on the North Sea.¹³⁴

At the same time, connecting electrolysers directly to renewable energy projects through “dedicated” green hydrogen plants offers benefits that allow these projects to be developed under circumstances where conventional grid-connected projects might not be practically feasible or economically viable. For example:

- a) In regions where the potential for green hydrogen production is large, and electricity demand is already largely being covered by wind and solar, high additional capacities of wind and solar can be directly connected to electrolysers, saving on grid connections costs that would only be of use for a small percentage of the time.

133 Including, but not limited to: EU EC's Impact Assessment SWD(2020) 176; EU EC JRC – Towards net-zero emissions in the EU energy system by 2050; FCH JU Roadmap.

134 Navigant (now Guidehouse), 2020, for North Sea Wind Power Hub. Integration routes for North Sea offshore wind 2050. <https://northseawindpowerhub.eu/knowledge/integration-routes-north-sea-offshore-wind-2050>

- b) Hydrogen can be stored cost-effectively over long periods of times, providing longer term storage and the ability to balance the electricity grid. This can improve the economics of renewable projects in areas where low renewable capture prices would have otherwise made the economics of projects unattractive; and
- c) Hydrogen can be transported over long distances cost-efficiently, particularly when large scale repurposed existing pipeline infrastructure is used. Again, green hydrogen can help relieve pressure of the increasingly congested electricity grid with high penetration of intermittent renewables.

These examples, although subject to the presence of an adequate hydrogen delivery system, demonstrate the nuanced aspects of creating an integrated energy system, and highlight the importance of considering all solutions when assessing the hydrogen supply perspective. This section aims to make an objective assessment of the green hydrogen supply potential.

3.2.1. Renewable energy supply potential

The basis for domestic green hydrogen supply is the **renewable energy supply potential** in the EU+UK.¹³⁵ This renewable energy potential is defined as the technical energy potential from natural solar and wind resources (onshore and offshore) – adjusted for land availability, environmental regulations, turbine spacing constraints, public acceptance, and technology deployment rates.

According to the European Commission’s Joint Research Centre (JRC), the technical renewable energy potential from solar and wind in the EU+UK is over 490,000 TWh per year.¹³⁶ Starting from this technical potential, practical constraints—per technology and per country—are applied to obtain a **realistic renewable energy supply potential**, estimated to be around 11,100 TWh per year, corresponding to approximately 5,600 GW (5.6 TW) of cumulative renewable installed capacity. The translation of the technical renewable energy potential of 490,000 TWh per year to the realistic renewable energy potential of 11,100 TWh per year is shown in Figure 22.

- **For solar PV**, the main issue is land availability. This study assumes that the share of non-artificial land area¹³⁷ available for ground-mount solar PV ranges between 0.1-2.0%, compared to the universal 3% assumed in the JRC’s ENSPRESOs reference scenario.¹³⁶ In this analysis, we use national population density as a proxy to refine the 0.1-2.0% land availability bracket for each country. In general, it is assumed that countries with higher population densities face more competition for land—from built-up environment including industrial estates and agriculture—and are able to dedicate less land to solar PV. In total, the land considered to be realistically available for ground-mount solar PV adds up to around 45,000 km², or 1.1% of the total EU and UK land area of about 4,000,000 km².¹³⁸ Rooftop PV potential is also included.
- **For onshore wind**, a key constraining factor is the minimal distance required between turbines and settlements. This study starts with ENSPRESO’s “EU-wide high restrictions” scenario, which describes a scenario in which the exclusion of surfaces for wind energy is high across all countries. Surfaces that do not meet country-specific minimum allowed setback distances from settlements are excluded, as are regions with legislations that explicitly forbid wind projects based on rotor diameter, hub height, or acceptable noise levels. Distance from settlements is set to 1200 m for small turbines and 2000 m for big turbines. In addition, we apply a minimal capacity factor constraint by only considering sites with capacity factors of 25% or higher, further narrowing the pool of potential wind projects across Europe.
- **For offshore wind**, we adopt the country figures of Wind Europe’s “Our Energy, Our Future” scenario, which estimates realistic offshore wind potential, including floating offshore technology, in the North, Baltic, and Mediterranean Seas in line with the European Commission’s 300 GW by 2050 target.

135 Throughout this study, ‘domestic’ strictly covers the EU+UK countries. Although this term is sometimes used interchangeably with ‘European’, non-EU countries are not included within the ‘domestic’ umbrella.

136 ENSPRESO – an open data, EU-27+UK wide, transparent and coherent database of wind, solar and biomass energy potentials. <https://ec.europa.eu/jrc/en/publication/enspreso-open-data-eu-28-wide-transparent-and-coherent-database-wind-solar-and-biomass-energy>.

137 All land areas excluding urban, industry, forests, transitional woodland-shrub, new energy crops, natural land, infrastructure, wetlands, water bodies, urban green leisure, and other natural land areas – as defined by the Land-Use based Integrated Sustainability Assessment (LUISA) classification.

138 World Bank. <https://data.worldbank.org/indicator/AG.LND.TOTL.K2?locations=EU>

FIGURE 22

From technical to realistic renewable energy potential in EU and UK (in TWh/year)

- Solar PV
- Wind onshore
- Wind offshore

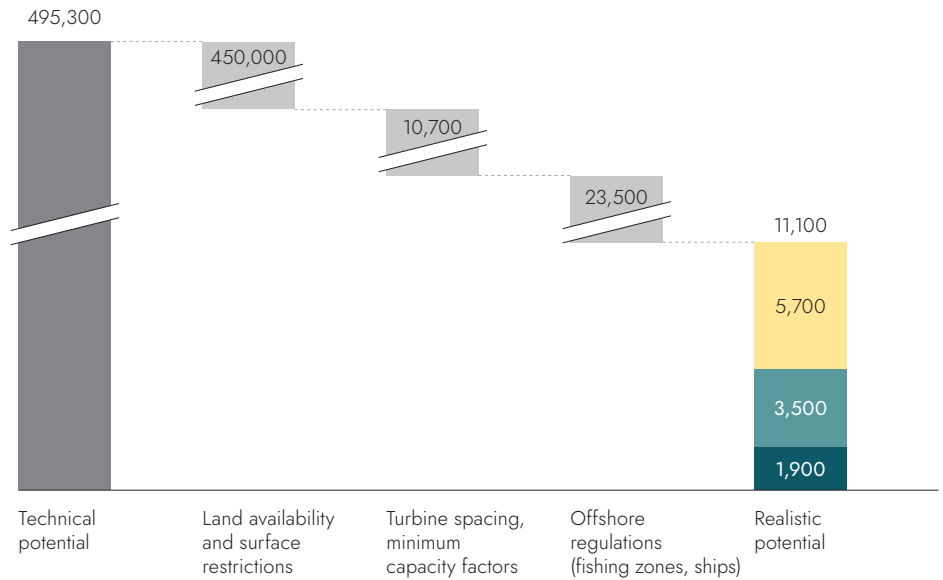

Source: Guidehouse analysis based on JRC's ENSPRESO database for solar PV and wind potential

To estimate the share of the EU+UK realistic potential of 5,600 GW—producing 11,100 TWh annually—that can be deployed over time, country-specific installation rates are assumed based on several sources.

For onshore wind and solar PV, installation rates are assumed to gradually reach 80% of the realistic installed capacity of 5,600 GW by 2050. As individual countries have different starting points and trajectories to reach this 2050 point, we use current shares of renewable sources in gross electricity consumption as a proxy to capture these differences.¹³⁹ For offshore wind, the installation rate is taken from Wind Europe's "Our energy, our future" report, which cites an operational capacity of 100 GW by 2030 and 260 GW by 2040, or 22% and 60% of the 2050 target, respectively.

These installation rates lead to an estimated renewable energy supply potential for EU+UK of around 3,300 TWh by 2030, 6,100 TWh by 2040, and 8,700 TWh by 2050. The corresponding cumulative installed capacities of solar PV, onshore wind, and offshore wind are 1,900 GW by 2030, 3,200 GW by 2040, and 4,500 GW by 2050, as shown in Figure 23.

139 Share of RES in gross electricity consumption, 2019. <https://ec.europa.eu/eurostat/web/energy/data/shares>. <https://ec.europa.eu/eurostat/web/energy/data/shares>. <https://ec.europa.eu/eurostat/web/energy/data/shares>.

FIGURE 23

Renewable energy potential (in TWh) with corresponding cumulative capacities (GW) in Europe in 2030, 2040, and 2050

TWh, electricity

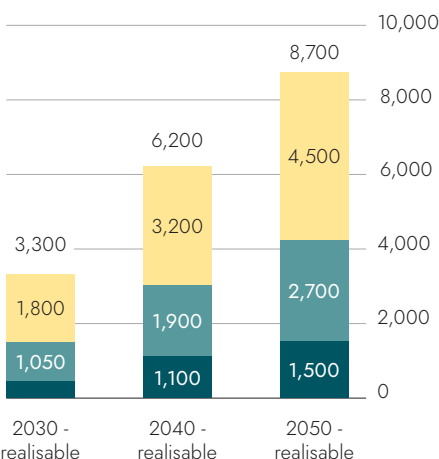

GW, installed capacity

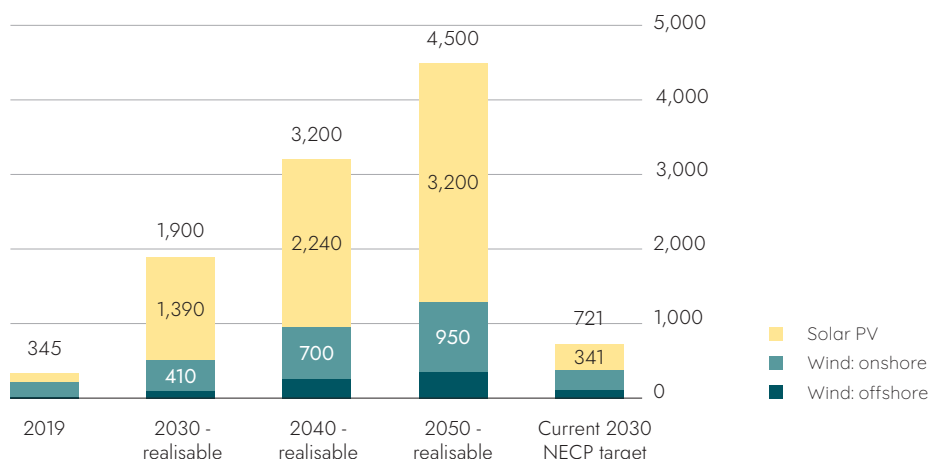

The cumulative target currently announced across EU+UK National Energy and Climate Plans (NECP) for 2030 is added for reference.

Source: Guidehouse analysis based on JRC's ENSPRESO database, Wind Europe (2020): "Our Energy, our Future"

These estimations, while based on well-founded external sources, are not intended to serve as a prediction how renewable energy deployment will or should happen. There are many reasons why deployment of renewables could diverge from the trajectory suggested by the above figures, many of which are highly region-specific. For example, public acceptance considerations already hamper the development of onshore wind and land-based solar-PV today, even in countries with a relatively low population density such as Sweden. Scaling up domestic renewables within EU+UK to the potential mentioned above will surely meet significant societal opposition. This could be one further reason to import green hydrogen from less densely populated areas along the European borders, as is explored in Section 3.4.

3.2.2. Green hydrogen supply potential

To translate the renewable energy potential in 2030, 2040, and 2050 into the green hydrogen supply potential for EU+UK, several factors are considered.

- **First, net supply for electricity is adjusted for by adding the production volumes that can be expected from all non-solar PV and wind power generation technologies**, including but not limited to nuclear, hydropower, bioenergy, and fossil fuels. To ensure that the generation mix used to estimate this **share of ‘other power generation’** is aligned with decarbonisation targets, we base the assumed future power mix on TYNDP’s 2020 Global Ambition scenario, extrapolated out to 2050, leading to 1,040 TWh in 2030, 590 TWh in 2030, and 470 TWh non-solar PV and wind generation in the EU+UK in 2050.¹⁴⁰
- **Second, as renewable electricity should be used as “electricity first—if possible”, a widespread electrification of end-use technologies is expected.** Starting from the total supply potential, we subtract final electricity demand as estimated by Gas for Climate in its Accelerated Decarbonisation scenario: 3,700 TWh in 2030, 4,100 TWh in 2040, and 4,500 TWh in 2050.¹⁴¹
- **Third, the impact of hydrogen use for dispatchable power – amounting to 12 TWh in 2030, 301 TWh in 2040, and 626 TWh in 2050 as described in Section 2.3 – is accounted for by adding the dispatchable renewable electricity that results from the hydrogen-to-power installation that contributes to meeting final electricity demand.** Herein we assume that hydrogen-to-power has a conversion efficiency of 50%, leading to hydrogen-to-power contributions of around 5 TWh in 2030, 150 TWh in 2040, and 320 TWh in 2050. Electrolyser efficiencies are assumed to be 71% in 2030, 76% in 2040, and 80% in 2050.¹⁴²
- **What remains is considered as the renewable electricity supply potential which can be made available for dedicated green hydrogen projects.** That is, potential solar PV and wind energy developments which have not been accounted for in power network planning and which are assumed to add limited incremental value to the power grid – economically and from a decarbonisation trajectory perspective. This renewable electricity supply potential adds up to 645 TWh in 2030, 2,740 in TWh in 2040, and 4,990 TWh in 2050.
- **Finally, conversion losses from electrolysis are factored in**, using the same efficiency assumptions mentioned above, to obtain the green hydrogen potential of around 450 TWh in 2030, 2,100 TWh in 2040, and 4,000 TWh in 2050.

140 TYNDP (2020). TYNDP 2020 Scenario Report. <https://2020.entsos-tyndp-scenarios.eu/>.

Includes geothermal, tidal, hydro, municipal solid waste, biogas, solid biomass, nuclear, fossil gas, fossil oil, coal. Similar to the final electricity demand scenario, for a select number of countries national figures were adapted to better align with national plans.

141 Gas for Climate (2020). Gas Decarbonisation Pathways 2020-2050. For a select number of countries national figures were adapted to better align with national plans.

142 BNEF, Hydrogen Project Valuation (H2Val) Model.

Aggregated EU and UK level results are illustrated in Figure 24. Again, it is important to note that these estimates only consider dedicated green hydrogen supply and exclude green hydrogen produced from grid-integrated electrolysis.¹⁴³ This is an important simplifying assumption as grid-integrated electrolysis, when combined with adequate market design and regulatory requirements¹⁴⁴, could play a key role in driving the creation of a liquid hydrogen market in the initial ramp-up years.

Initially, electrolyzers will mainly be deployed in industrial clusters close to hydrogen demand using electricity from the grid at high utilisation factors. As hydrogen demand increases and electrolyser installation costs decline, electrolyzers move to renewable energy sources and hydrogen pipelines connect supply and demand. Longer term, local, demand-sited electrolyzers may remain to provide flexibility to the electricity grid alongside batteries and other dispatchable technologies. They may also be justified if electricity grid expansions are too difficult for economic or practical reasons. Electricity and gas TSOs alike are already today exploring hybrid, cross-sectoral solutions to integrate large volumes of variable renewable energy into the European energy system cost-optimally—without overdesigning the power grid.¹⁴⁵

143 For example, Germany's national hydrogen strategy has set a 5 GW electrolyser capacity target for 2030, with an additional 5 GW until 2035 (latest 2040).
 144 For example, additionality of renewables, temporal correlation with electricity prices or grid emission factors.
 145 See for example: North Sea Wind Power Hub (2021). Towards the first hub-and-spoke project. <https://northseawindpowerhub.eu/node/178>.

FIGURE 24
 Translating renewable energy supply potential to green hydrogen supply potential – taking into account the needs for electricity and conversion losses – in 2030, 2040, and 2050

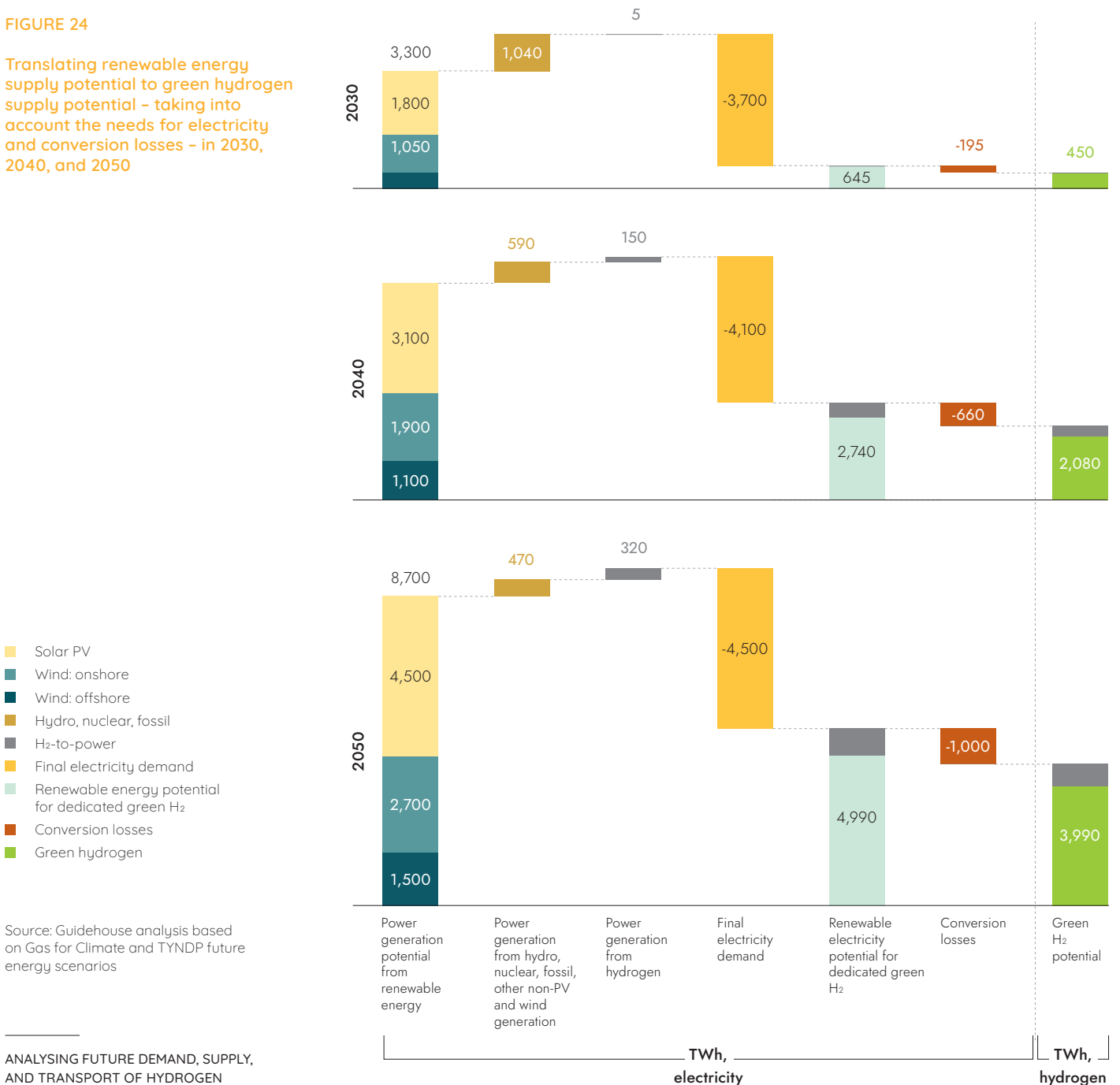

Even after considering the needs for electricity, Figure 24 shows that there remains a substantial volume surplus of renewable energy that can generate green hydrogen in Europe: around 450 TWh in 2030, 2,100 TWh in 2040, and 4,000 TWh in 2050.

Although the needs for electricity as analysed above are a major driver of the green hydrogen supply potential, other direct and indirect factors along the supply chain must also be carefully managed to ensure reliable, sustainable, and affordable supply, including:

- **Critical minerals:** While not exclusively related to green hydrogen, the rapid deployment of clean energy technologies such as solar PV, wind, batteries, and electrolyzers as part of energy transitions implies a significant increase in demand for minerals. Until recently, the energy sector represented a small part of total demand for minerals. However, in a scenario that meets the Paris Agreement goals, their share of total demand rises significantly over the next two decades to over 40% for copper and rare earth elements, 60-70% for nickel and cobalt, and almost 90% for lithium.¹³⁶ The rapid growth of hydrogen as an energy carrier also underpins major growth in demand for nickel and zirconium for electrolyzers, and for platinum-group metals for fuel cells. Today's mineral supply and investment plans are geared to a world of more gradual action on climate change and must be revisited to support accelerated energy transitions. According to the IEA's report "The Role of Critical Minerals in Clean Energy Transitions", these risks to the reliability, affordability, and sustainability of mineral supply are manageable, but will require action from policy makers to ensure adequate investment in new sources of supply, recycling, supply chain resilience, and strengthened international collaboration between producers and consumers.¹⁴⁶
- **Water use:** Hydrogen production through electrolysis requires water as a main input. From a purely stoichiometric approach, in order to produce 1 kg of hydrogen 9 kg of water is needed. However, after taking process inefficiencies and the process of water demineralisation into consideration, the typical water consumption amounts to between 18 - 24 kg of water per kilogram of hydrogen.¹⁴⁷ For reference, if the entire projected EU+UK demand in 2050, consisting of 2,250 TWh or 68 million tonnes, were supplied with fresh water, total water consumption would be around 1,400 million tonnes or 1,400 cubic hectometres. By comparison, the EU agriculture sector uses around 98,000 cubic hectometres of water today.¹⁴⁸ Against the backdrop of rising temperatures and changing precipitation, existing and expected regional water supplies must be analysed carefully to ensure that local water supplies are not depleted for water electrolysis, particularly in hot and dry areas where solar PV resource is more abundant. If feasible, seawater desalination plants can be used with limited cost and efficiency impacts, and multipurpose desalination facilities can potentially be implemented to provide local benefits.¹⁴⁷

146 IEA (2021), The Role of Critical Minerals in Clean Energy Transitions, IEA, Paris <https://www.iea.org/reports/the-role-of-critical-minerals-in-clean-energy-transitions>.

147 IRENA (2020), Green Hydrogen Cost Reduction – scaling up electrolyzers to meet the 1.5C climate goal. https://irena.org/-/media/Files/IRENA/Agency/Publication/2020/Dec/IRENA_Green_hydrogen_cost_2020.pdf.

148 European Environment Agency (2021), Use of freshwater resources in Europe. <https://www.eea.europa.eu/data-and-maps/indicators/use-of-freshwater-resources-3>.

149 Electrolyser capex figures are selected following a literature review of several studies, including BNEF: Hydrogen Project Valuation (H2Val) Model; Agora-AFRY: No-regret hydrogen; Florence School of Regulation: Clean Hydrogen Costs in 2030 and 2050. Additional techno-economic parameters (capex, opex, efficiency, discount rate) are specified in Appendix B.

3.2.3. Green hydrogen production costs

Levelised production costs of green hydrogen, expressed in €/kg, are determined at country-level assuming hydrogen is produced from dedicated solar PV, onshore wind, or offshore wind projects. Herein we model renewable energy projects paired with alkaline electrolyzers assumed to cost 270 €/kW in 2030, 200 €/kW in 2040, and 135 €/kW in 2050, plus operating expenses. Solar PV and wind capacity factors per country are taken from the ENSPRESO database and explain the variance in cost levels between countries.¹⁴⁹

For each country, green hydrogen production costs per technology are plotted against green hydrogen supply potentials (excluding hydrogen for power) as estimated using the methodology detailed in Section 3.2.2. Results, displayed in Figure 25 show that a substantial share of the green hydrogen potential can be supplied at cost-competitive levels, especially in 2040 and 2050:

- By 2030, up to 150 TWh of green hydrogen can be produced at 2.0 €/kg or less and around 10-15 TWh around 1.5 €/kg. The remaining ~300 TWh would cost more than 2.0 €/kg.
- By 2040, up to 1,600 TWh of green hydrogen can be produced at 2.0 €/kg or less of which up to 500 TWh around 1.5 €/kg. The remaining ~500 TWh would cost more than 2.0 €/kg.
- By 2050, almost all of the potential 4,000 TWh of green hydrogen can be produced for less than 2.0 €/kg, of which up to 2,500 TWh below 1.5 €/kg and around ~600 TWh at 1.0 €/kg. The remaining ~900 TWh would cost between 1.5 €/kg and 2.0 €/kg.

For reference, green hydrogen delivered at 2.0 €/kg can compete with grey hydrogen at a CO₂ price of around 100 €/tCO₂. At 1.5 €/kg, the break-even CO₂ price is around 50 €/tCO₂, and green hydrogen delivered at 1.0 €/kg outcompetes grey hydrogen outright, even without a CO₂ price. However, this does not consider that grey hydrogen is currently produced on-site at constant supply. Electrolysis-based hydrogen using grid electricity can achieve a similar baseload output, but only at smaller scale and with a carbon footprint dependent on the grid that feeds it. Dedicated green hydrogen projects from variable renewable energy can be delivered at large scale with a constant supply. However, this requires a dedicated hydrogen pipeline and storage delivery system to “firm” the variable production profile which comes at additional cost not captured in the production costs shown in Figure 25.

Note: Green hydrogen “firming” requirements, i.e. shaping variable supply to match off-takers’ consumption profiles, vary depending on the supply technology and end-use sector. This process will make use of dedicated gas storage facilities combined with smart grid operation, as is done to provide secure and baseload natural gas supply to consumers today.

These expected production costs assume a significant decline compared to today’s costs between 2.5 and 6.2 €/kg according to IEA.¹⁵⁰ Achieving such cost reductions will be subject to improvements in electrolyser design and construction, economies of scale, and greater efficiency and flexibility in operations, under continued policy support driven by ambitious European and national climate mitigation goals.

Note that future green hydrogen production cost estimates vary widely amongst literature studies: BloombergNEF (BNEF) estimates that green hydrogen can be produced well below 2.0 \$/kg (1.65 €/kg) by 2030 and well below 1.0 €/kg (0.83 €/kg) by 2050 in most markets¹⁵¹; and a study by the Florence School of Regulation forecasts a range of 0.9-2.3 €/kg for solar PV and 1.7-2.8 €/kg for offshore wind by 2030 and 0.6-1.7 €/kg for solar PV and 1.4-2.1 €/kg for offshore wind by 2050.¹⁵² In these forecasts, the lower end of the cost range assumes more aggressive electrolyser capex reductions, increased utilisation factors, or a combination of both, than in this study. Other reports, such as IEA’s Future of Hydrogen¹⁵⁰ and IRENA’s Green Hydrogen Cost Reduction¹⁵⁴ cite somewhat higher costs for green hydrogen of between 1.1 and 3.4 €/kg by 2030.

150 IEA (2019). The Future of Hydrogen. <https://www.iea.org/reports/the-future-of-hydrogen>
<https://www.iea.org/reports/the-future-of-hydrogen>

151 BNEF, Hydrogen Project Valuation (H2Val) Model.

152 Clean Hydrogen costs in 2030 and 2050: a review of the known and the unknown. <https://www.europeanfiles.eu/energy/clean-hydrogen-costs-in-2030-and-2050-a-review-of-the-known-and-the-unknown>.

153 IRENA (2019) A renewable energy perspective <https://www.irena.org/publications/2019/Sep/Hydrogen-A-renewable-energy-perspective>

154 IRENA (2020) Green hydrogen cost reduction <https://irena.org/publications/2020/Dec/Green-hydrogen-cost-reduction> and IEA (2021) net-zero by 2050 <https://www.iea.org/reports/net-zero-by-2050>

FIGURE 25

Supply-production cost curves of European (EU+UK) green hydrogen supply potential from dedicated renewables in 2030, 2040, and 2050

- Wind onshore
- Wind offshore
- Solar PV

2030

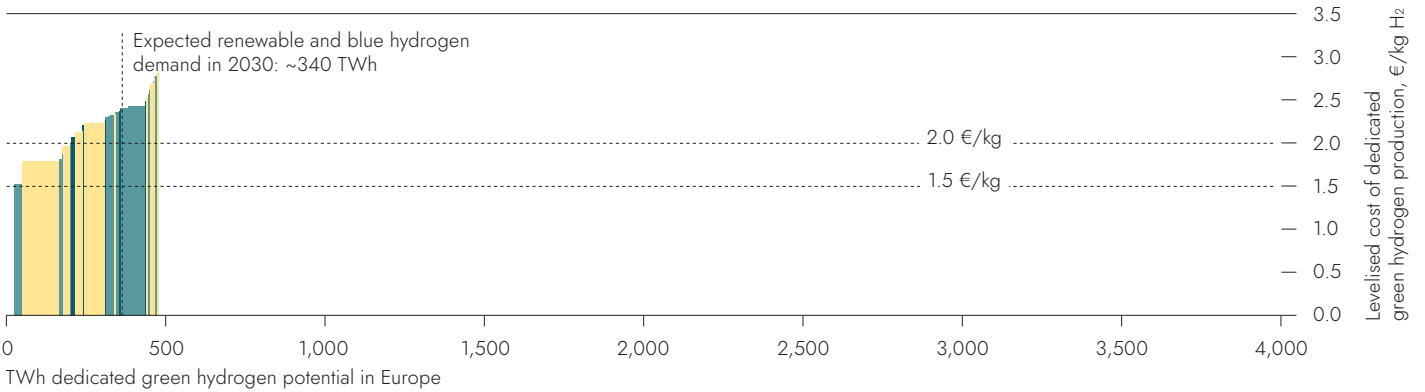

2040

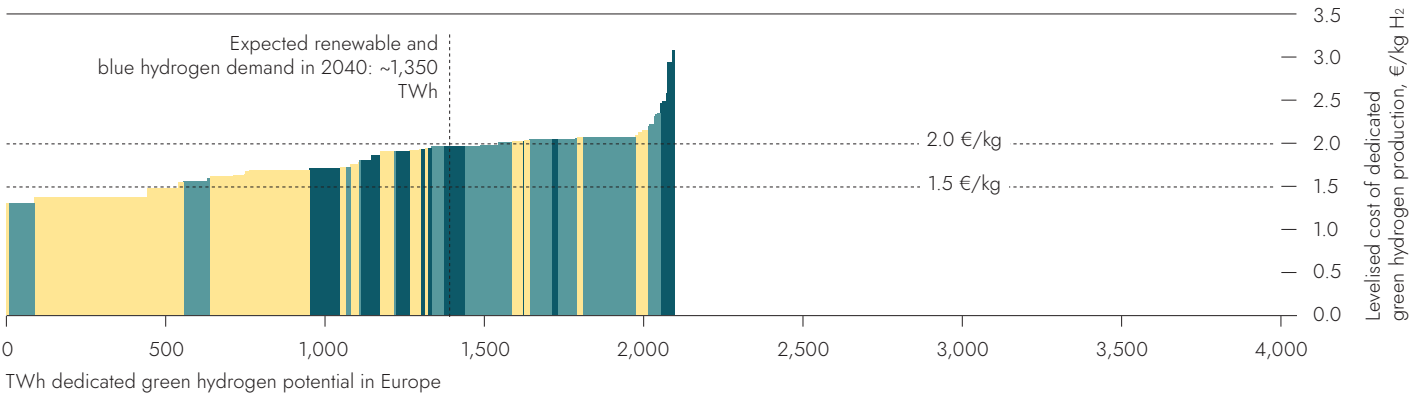

2050

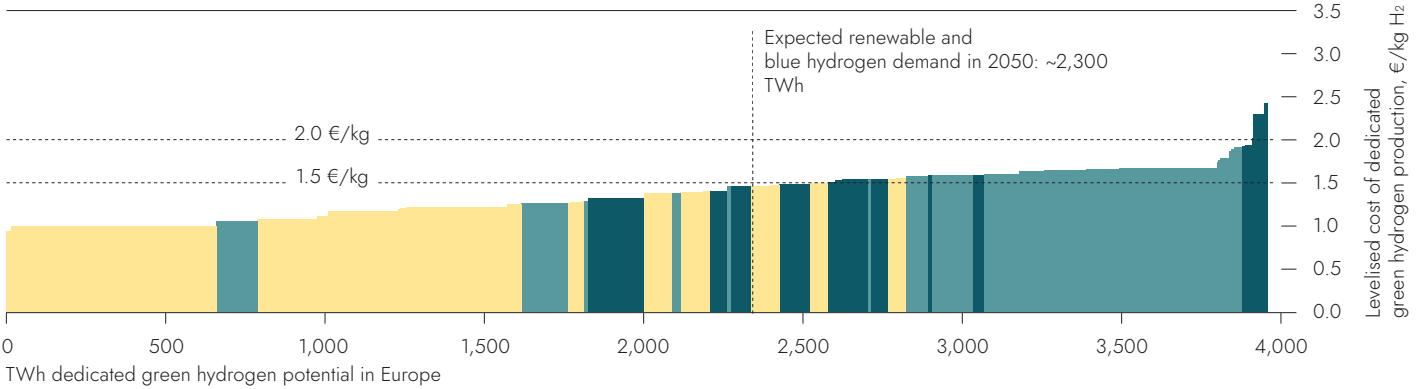

Source: Guidehouse analysis assuming electrolyser costs as reported by BNEF and RES-E capacity factors from JRC's ENSPRESO database

Each volume 'slice' on the x-axis represents green hydrogen production potential—after considering the needs of the electricity market—in a specific country.

The hydrogen supply-cost estimates in Figure 25 show that, by 2040 and 2050, there can be sufficient green hydrogen supply available in Europe to meet projected European demand in all sectors at cost levels competitive with grey hydrogen and other fossil alternatives in the different end-use sectors. By 2030, taking into account final electricity demand, land availability, environmental regulations, and technology deployment rates, the estimated green hydrogen supply potential does not exceed the projected 340 TWh demand. This means that especially during the initial ramp-

up phase—although not exclusively during this time—other renewable and blue supply sources including domestic blue hydrogen and green hydrogen imports from neighbouring regions will be needed to enable a quick start to the use of hydrogen to drive emission reductions.

3.2.4. Green hydrogen and electrolysis in national hydrogen strategies

Policy support will play a crucial role to scale green hydrogen up to 2030. In A hydrogen strategy for a climate-neutral Europe, the European Commission announced a strategic objective to “install at least 40 GW of green hydrogen electrolyzers by 2030 and the production of up to 10 million tonnes of green hydrogen in the EU”. The first of these two objectives—deploying 40 GW of electrolyzers by 2030 in the EU, if met—can be expected to produce around 110 TWh of hydrogen from electrolysis¹⁵⁵ National hydrogen strategies announced to date already foresee around 37 GW of cumulative installed capacity by 2030, and a number of countries (Austria, Czech Republic, Denmark, Slovakia, Hungary, Bulgaria, Greece) are still developing their strategies.

At the same time, these announced targets are non-binding and in some cases ambiguity exists regarding the inclusion of blue hydrogen. In the UK it is also unclear whether the announced target includes Scotland or if Scotland has set its own 5 GW target. Importantly, as a share of the planned electrolyser capacity will be grid-connected, the extent to which these volumes can be classified as green hydrogen will depend on how this will be defined in the EU Taxonomy for sustainable activities and other relevant regulations.¹⁵⁶

155 Assuming electrolyzers are operated at 4000 full load hours and 70% conversion efficiency.

156 According to The EC’s Delegated Regulation: Criteria for Sustainable Hydrogen Activities approved on 21 April 2021, hydrogen will be considered to contribute substantially to climate change mitigation if it complies with the life cycle greenhouse gas emissions savings requirement of 73.4% resulting in 3tCO₂eq/tH₂. <https://www.lexology.com/library/detail.aspx?g=a2943c48-e8b7-4ac2-bdc4-872d25362427>

FIGURE 26

National hydrogen strategies and electrolysis targets by 2030

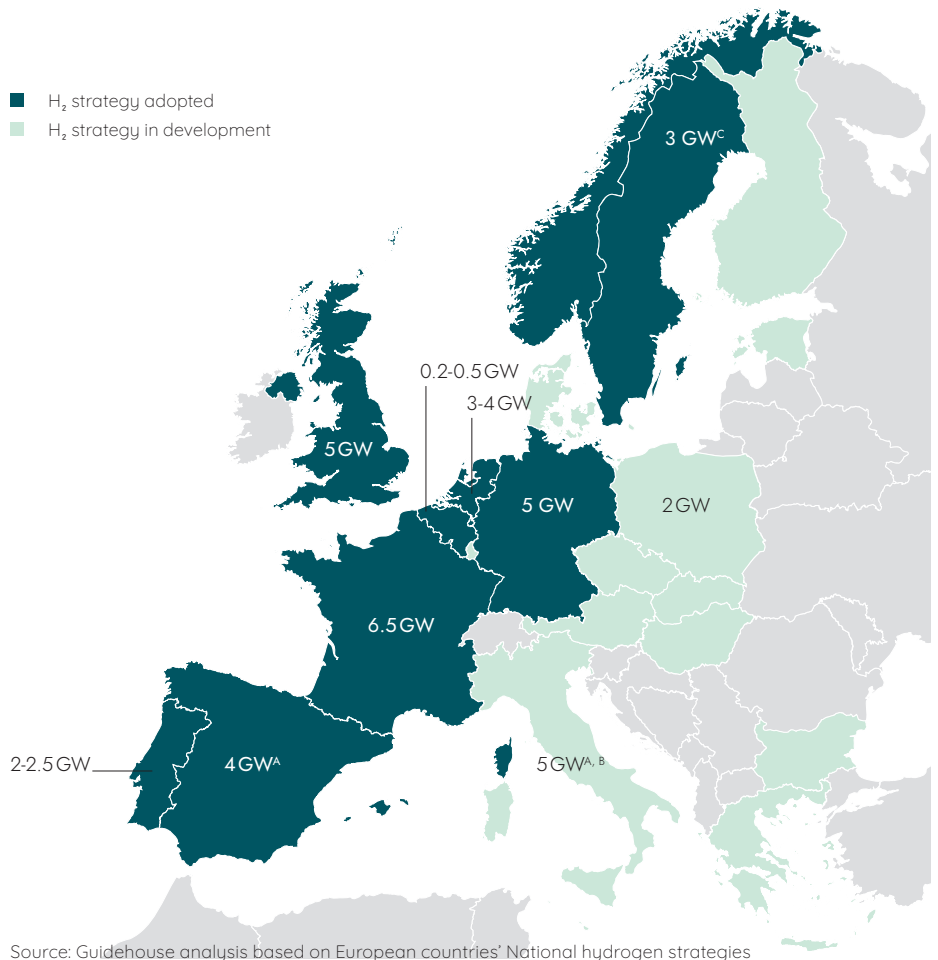

A Spanish and Italian figures refer to mobilised investments while German and French figures refer to spent public funds.

B Figures according to National Hydrogen Strategy Preliminary Guidelines.

C 3GW given for Sweden is suggested in the governmental initiative Fossil Free Sweden hydrogen strategy as planning goal for 2030. The official hydrogen strategy for Sweden is still under development by the Swedish Energy Agency, to be presented in Nov 2021.

Nonetheless, if these national ambitions and non-binding targets can be translated into adequate regulatory and financial incentives through further policy support and market design, it is reasonable to posit that the 40 GW by 2030 European hydrogen target could be met. Europe would then work towards the European Commission's second, much more aspiring, ('up to') 10 Mt of green hydrogen by 2030 ambition, which corresponds to 330 TWh hydrogen. However, given the virtually non-existent market for green hydrogen today and an estimated green hydrogen supply potential of 260 TWh, achieving this volume target seems unlikely without incentives for additional sources of market supply, including for blue hydrogen and imports.

3.2.5. Summary

In summary, an analysis of the green hydrogen supply potential in Europe—taking into account final electricity demand, land availability, environmental regulations, and technology deployment rates—shows that by 2040, there can be sufficient green hydrogen supply available in Europe to meet projected demand in all sectors. In the ramp-up phase to 2030, additional supply sources including domestic blue hydrogen and green hydrogen imports from neighbouring regions will be needed to meet local and regional demand in absence of a fully interconnected European hydrogen backbone and enable a quick start to the use of hydrogen to drive emission reductions.

By 2040 and 2050, European supply potential for hydrogen could exceed final demand quite substantially. Even then, supplying hydrogen entirely from within Europe might not be optimal in all circumstances due to a range of practical, economic, and political reasons.

First, reaching the potential is subject to a step-change in ambition as it requires more than 2 times more renewable energy capacity to be built by 2030 compared to what is targeted in existing national climate and energy plans. As shown in Figure 23, total Europe-wide NECP installed capacity targets for solar PV and wind by 2030 add up to around 720 GW, whereas reaching the potential outlined in this study would require almost 1,700 GW to be deployed by 2030, and 4,500 GW by 2050.

Second, not all domestic green hydrogen supply potential will—excluding policy support—be cost-competitive with alternative decarbonised options such as blue hydrogen, especially in the early 2030s, and green hydrogen imports, towards the late 2030s and 2040s. At production costs above 2.0 €/kg, green hydrogen without subsidies will be outcompeted by large-scale greenfield blue hydrogen projects and CCS-retrofitted steam methane reformers, which can reach production costs of around 2.0 €/kg at CO₂ prices of 50 €/tCO₂.¹⁵⁷ Furthermore, green hydrogen production might face additional costs due to the intermittency of renewable electricity, which have not yet been included in the calculations.

Third, the supply-demand picture is highly country-specific. The fact that Europe has enough supply potential to meet demand on aggregate does not mean that this is the case for each member state. Some countries have the potential to be in a renewable energy surplus whereas others are likely to find themselves in a deficit. Accordingly, some countries can become net exporters of renewable energy – as electricity, hydrogen, or both – whereas others will likely need to import. These international energy flows will be driven by economics as well as energy politics and, depending on the country, can include production from within and from outside Europe.

Fourth, NIMBY-ism (“Not In My BackYard”) already hampers the development of onshore wind and land-based solar-PV today, even in countries with a relatively low population density such as Sweden. Scaling up domestic renewables within EU and UK to the potential will surely meet significant societal opposition. This could be one further reason to import green hydrogen from less densely populated areas along the European borders whilst also providing an income to these neighbouring countries.

For these reasons, complementing domestic production with hydrogen imports by pipeline from neighbouring regions can be a viable strategy for the EU, even though European supply potential is sufficient. This will be explored in Section 3.4.

¹⁵⁷ Assuming a natural gas price of 20 €/MWh. See blue hydrogen production costs in Figure 29.

FIGURE 27

Green hydrogen supply potential from dedicated renewables per major EU and UK region in 2030, 2040, and 2050 (in TWh)

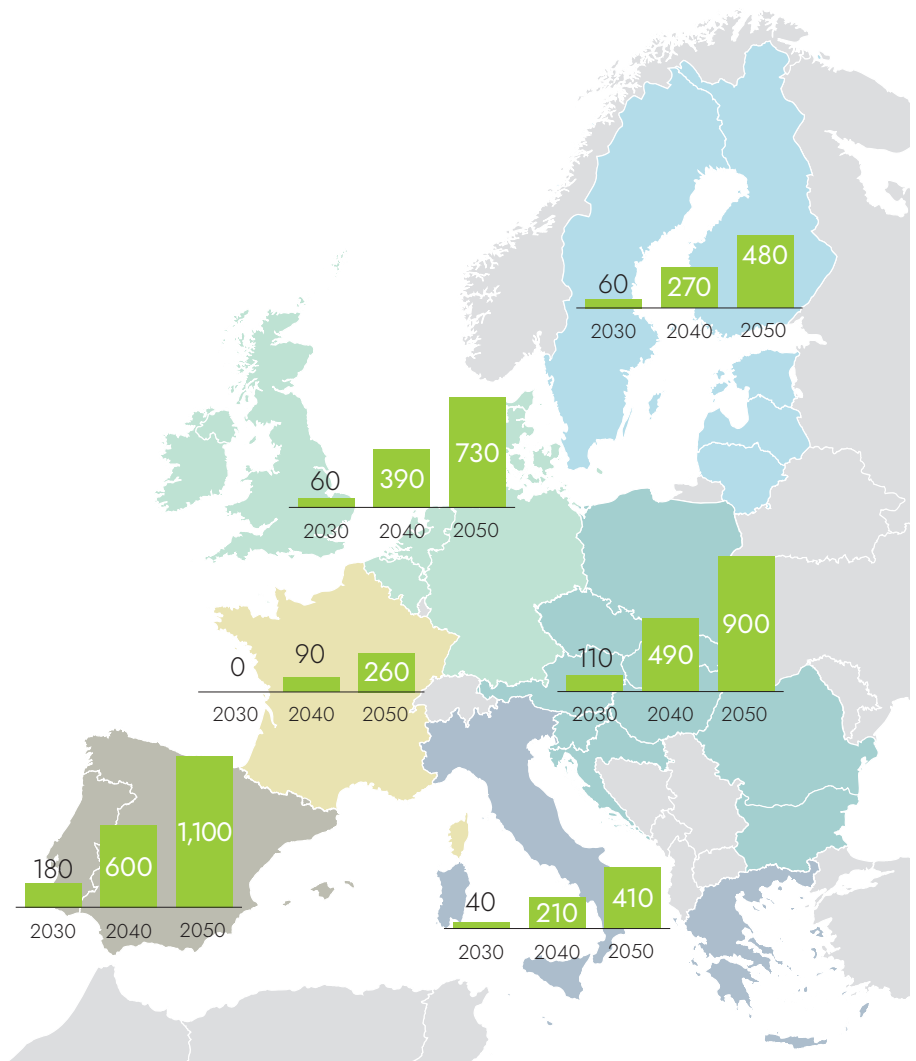

3.3. Blue Hydrogen

Assuming sufficient natural gas is available, also in view of the expected decrease in demand for its direct use, the technical potential of blue hydrogen production is in theory only limited by CO₂ storage. Onshore and offshore aquifers and hydrocarbon fields together add up to over 100 Gt CO₂ storage potential in the European Union and the UK.¹⁵⁸ Assuming an emission factor of 0.018 tCO₂ per MWh of blue hydrogen under a high, 94% capture rate for Auto Thermal Reforming technology,¹⁵⁹ this would mean that technical blue hydrogen potential is virtually unlimited at over 360,000 TWh of hydrogen.

As with green hydrogen, the very large European potential for blue hydrogen is limited by various factors. Blue hydrogen today faces regulatory and political acceptance constraints. The Gas for Climate 2019 study¹⁵⁸ explored, in Appendix E (see in particular Table 36 on page 129) the public acceptance and legal possibilities and barriers of CO₂ storage across Europe. In the Netherlands for example, political acceptance of blue hydrogen is high compared to other European countries: The Dutch government now stimulates CCS via its SDE++ support scheme,¹⁶⁰ albeit not beyond 2035 and limited to 50% of the necessary emission reduction in industry and power generation by 2050. The 2019 Gas for Climate study also highlighted the necessity to minimise methane leakage of natural gas during both exploration and transport. Gas TSOs are working to address this issue, but action by gas producing countries will be required as well.

158 Gas for Climate (2019)

159 H-Vision (2020) annex to main report.

160 <https://www.klimaatakkoord.nl/binaries/klimaatakkoord/documenten/publicaties/2019/06/28/klimaatakkoord-hoofdstuk-industrie/klimaatakkoord-c3+Industrie.pdf>

Future costs of blue hydrogen are very much dependent on the technology, scale, and proximity to CO₂ storage options, as well as the price of the natural gas feedstock. This study considers two blue hydrogen production use-cases with a high (95%) and low (60-70%) capture rate scenario for 2030 and onwards:

- **Greenfield ATR:** a large-scale (> GW size) newly built Auto Thermal Reformer (ATR)¹⁶¹ + Carbon Capture and Storage (CCS) with high 95% capture rate
- **Brownfield SMR:** adding CCS to an existing Steam Methane Reformer (SMR), onsite with 60-70% capture rate

In Figure 28, for both cases, levelised production costs are shown under different input cost ranges. The main differences between the high and low cases include CO₂ transport and storage costs – ranging between 20 and 50 €/tCO₂¹⁶² – and the assumed depreciation levels of the existing SMR units. Three scenarios are included for CO₂ price in the EU ETS for 2030, from 50-150 €/tCO₂. This represents the uncertainty and different views on the CO₂ price development, which already reached 50 €/tCO₂ today. The estimates for 2030 differ: the European Commission estimates a price of 60 €/tCO₂¹⁶³ by 2030, BNEF estimates 100€/tCO₂¹⁶⁴, while another recent study even forecasted 129€/tCO₂¹⁶⁵ by 2030. The natural gas price is an important cost factor too and is assumed to be 20€/MWh and constant. It should be noted that future natural gas prices in a net zero energy system can fall well below 20 €/MWh, translating into blue hydrogen costs as low as 1 €/kg - less than the low estimate shown in Figure 28.

The cost advantage of brownfield SMR blue hydrogen projects compared to greenfield ATRs decreases during the 2030s due to rising CO₂ prices and the lower capture rate. Taking into account also the fact that many brownfield SMR projects would be geographically distanced from potential CO₂ storage sites, this study assumes that 50% of the 270 TWh/year existing SMR fleet can be retrofitted with CCS to produce blue hydrogen. The retrofitting is assumed to be gradually deployed up to 2035. The other 50%, which can technically be retrofitted with CCS, but at a cost that makes them economically uncompetitive, are assumed to cease operation over time.

161 ATR is considered as the best suited technology (large-scale) blue hydrogen production, mainly for the high CO₂ capture rate of ~95% that it enables, but also several other reasons such as operational flexibility and economies of scale, more details found in H-Vision (2020) and H21 (2018)
 162 H-Vision (2020), Gas for Climate (2019), IEA (2019), GH expertise
 163 EC Impact Assessment (2020) https://ec.europa.eu/clima/sites/clima/files/eu-climate-action/docs/impact_en.pdf
 164 Bloomberg (2021) <https://www.bloomberg.com/news/articles/2021-04-01/the-eu-s-carbon-market-is-about-to-enter-its-turbulent-20s>
 165 Osorio et al (2021) available at <https://www.sciencedirect.com/science/article/pii/S0306261921003962>
 166 Main assumptions: CAPEX and capture rate: Brownfield SMR= 375-1,175 €/kW and 60-66%, Greenfield ATR= 800-1,000 €/kW and 94%. Further assumptions found in appendix, Table 24.Table 23.

FIGURE 28
Costs of blue hydrogen production under different CO₂ prices and capex assumptions by 2030¹⁶⁶

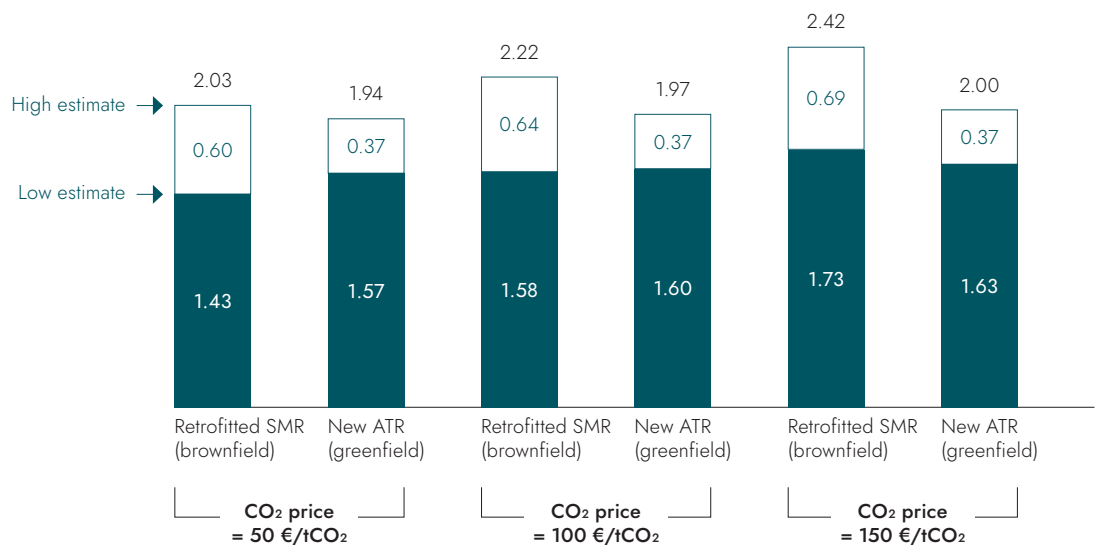

Natural gas feedstock prices are assumed to be 20 €/MWh across all cases.¹⁶⁵
 Source: Guidehouse analysis with input assumptions taken from the H-Vision project in Port of Rotterdam

Greenfield ATR projects can reach high CO₂ capture rates of 94% and are therefore almost unaffected by the rising CO₂ price. These larger blue hydrogen projects are also expected to be relatively close to the (subsea) CO₂ storage sites, for instance at the ports of Rotterdam in the Netherlands and Teesside in the UK, limiting CO₂ transport costs. This could mean that their production cost could be closer to the lower end of the range shown in the figure, i.e. 1.4-1.6 €/kg.

With greenfield blue hydrogen production costs of 1.4-2.0 €/kg, generally near hydrogen demand hubs, greenfield blue hydrogen production in Europe can enable a quick start of the use of hydrogen to drive emission reductions. By doing so, blue hydrogen could serve as an accelerator of hydrogen developments on the demand and infrastructure side. Blue hydrogen could also complement the variable supply of green hydrogen which is dependent on the daily and seasonal profiles of renewables.

Beyond 2030, deployment of new blue hydrogen projects will face increasing competition from green hydrogen, as this becomes more widely available at lower costs. The costs of green hydrogen will come down over time with rapidly decreasing electrolyser and renewable electricity costs, and more widely available as Europe's hydrogen pipeline infrastructure grows, while the costs of greenfield blue hydrogen are expected to remain constant with potentially increasing operating cost. At the same time, there will still be a role for (by then) existing ATRs—which have a lifespan of 25 years—to continue producing as the marginal supply option and to contribute to system integration and balancing of variable green hydrogen through firm, baseload hydrogen production.

In countries where CCS acceptance is low or where limited geological storage opportunities exist, CO₂ would have to be transported over substantial distances by pipeline or by ship, which would add approximately 0.1 €/kg H₂ to the cost of the project.¹⁶⁷

Below the announced greenfield blue hydrogen projects are described and accumulated, which are limited to a few countries. In reality more projects might emerge before 2040, which are not accounted for in this study.

The majority of the announced greenfield blue hydrogen projects are in the UK, accounting for 102 TWh/year by 2030 (Acorn CCS, H₂¹⁶⁸, H₂H Saltend, H₂ Teesside, HyNet North West, project Cavendish and Humber zero). The total capacity of all announced projects grows to 179 TWh/year by 2035, when the large H₂1 project aims to fully materialise. This would account for more than the UK national target of 5 GW installed hydrogen production capacity by 2030, which assuming 8,000 load hours per year would come to 40 TWh in 2030. There are however uncertainties about this 5 GW target, for instance seeing that Scotland also separately set a 5 GW target by 2030¹⁶⁹. The substantial capacities reflect the UK's large CCUS ambition which includes the goal to establish four CCUS hubs and clusters by 2030, with €1.15 billion of funding announced¹⁷⁰. Additionally, in the UK blue hydrogen is anticipated to play a substantial and widespread role in decarbonising sectors supplied by natural gas today, including heating of residential and commercial buildings, while also blending hydrogen in the natural gas network is anticipated at large scale.

Outside the UK, mainly due to political and/or regulatory uncertainty, only a few greenfield blue hydrogen projects have been proposed or announced. In the Netherlands, H-Vision¹⁷¹ and Aramis together plan to produce around 33 TWh/year of greenfield blue hydrogen by 2030 and in Germany, the H₂morrow project is assumed to add another 9 TWh/year. In Italy, the Adriatic Blue CCS project is expected to have a capacity of 23 TWh/year by 2030. In other EU countries such as France¹⁷², no capacities have been announced or projected, so no greenfield blue hydrogen is assumed other than the above-mentioned projects.

In total, **greenfield blue hydrogen supply potential in the EU+UK**, as per projects announced today, account for 167 TWh/year by 2030 and 244 TWh/year by 2035, with 70% being in the UK in 2035. Adding **brownfield blue hydrogen** production to this number leads to a total of 234 TWh/year by 2030 and 378 TWh/year by 2035 and onwards.

167 <https://www.globalccsinstitute.com/archive/hub/publications/119811/costs-co2-transport-post-demonstration-ccs-eu.pdf>

168 The H₂1 project wants to deploy 12.15 GW of new ATR capacity in 9 1.35 GW units and this study projects 2 to materialize by 2030 and the other 7 by 2035. H₂1 (2020) available at <https://www.northerngasnetworks.co.uk/wp-content/uploads/2018/11/H21-Meeting-UK-Climate-Change-Obligations.pdf>

169 <https://www.gov.scot/news/building-a-new-energy-sector/>

170 <https://www.globalccsinstitute.com/news-media/press-room/media-releases/uk-government-set-to-fund-four-ccs-hubs-and-clusters/>

171 Assuming the reference scenario of 3.2 GW installed ATR capacity.

172 <https://www.equinor.com/en/news/20210218-join-forces-engie-hydrogen.html>

3.4. Imports of green and blue hydrogen

“We are excited to partner with the European Commission and leverage Ukraine’s excellent natural resources to support decarbonisation of Europe through accelerating the export of green hydrogen from Ukraine to Europe.”

Oleksander Riepink
President
Ukrainian Hydrogen Council

Major potential green hydrogen supply regions outside of the EU27+UK include North Africa and Ukraine. Taking into account natural resources, physical interconnections, and technological developments, both regions have been identified as priority partners for cooperation on clean hydrogen in the European Commission’s EU Hydrogen Strategy¹⁷³ and are frequently mentioned in discussion papers published by industry.¹⁷⁴

In addition, the thinking and strategising about possible green hydrogen imports, shipped as ammonia or methanol, from overseas regions with export ambitions such as the Middle East, Chile, and Australia, is gaining traction. However, because of the high conversion and reconversion costs of ship transport, these projects tend to focus on decarbonising demand sectors where hydrogen-derived carriers such as ammonia and methanol can be consumed directly, e.g. in shipping.

Blue hydrogen imports from natural gas producing countries like Norway and Russia are also an option. Concepts and studies on this subject have been announced, including for example a proposed blue hydrogen export pipeline from Norway to continental Europe by Equinor and Norway’s gas system operator Gassco,¹⁷⁵ two organisations involved in natural gas exports to Europe today. Similarly, Russian state-owned company Gazprom has announced plans to further develop its own technological competencies. Gazprom’s focus areas include “the production of hydrogen from methane with zero CO₂ emissions and the development of hydrogen transport methods, inter alia, for the purpose of export”.¹⁷⁶ Russia, in theory, also has a large renewable energy potential in the form of solar, wind, hydro, and biomass. Even though it would represent a remarkable change in strategic direction, tapping into this renewable energy potential using repurposed existing natural gas pipeline infrastructure could offer Europe with an additional source of large-scale green hydrogen.

In Russia and Norway blue hydrogen could be produced using natural gas at exploration and production costs of below 5€/MWh, which would lead to blue hydrogen production costs of around 1 €/kg by 2030 if produced at large scale using greenfield ATRs. This is lower than the estimates in Figure 28, which assume natural gas prices as delivered in locations where the majority of blue hydrogen projects today are being planned.

At the same time, the benefit of lower blue hydrogen production costs in these potential export regions needs to be weighed against the alternative of importing natural gas and producing blue hydrogen within the EU+UK. Factors to consider here include the location of and public support for CCS, CO₂ transport and storage costs, pipeline repurposing costs and availability, and methane leakage. Over time, blue hydrogen is also expected to face increasing cost-competition from green hydrogen assuming that electrolyser and renewable energy technology costs develop as shown in Figure 25 and as forecasted by other recent studies mentioned previously.¹⁷⁷

This green hydrogen could be produced domestically, as analysed in Section 3.2, or it could be imported from European neighbouring regions. Given their proximity and renewable resource abundance, imports from solar PV-powered hydrogen produced in North Africa (e.g. Morocco and Algeria) and hydrogen from solar PV and onshore wind in Ukraine could be an attractive option.

Applying a simplified supply potential analysis using the same methodology as previously done for the EU+UK in Section 3.2, we estimate how much green hydrogen can be produced from dedicated renewables in Ukraine, Morocco, and Algeria, also considering local final electricity demand. The main assumptions are shown in Table 3 below and the supply-cost curves are displayed in Figure 29.

173 A hydrogen strategy for a climate-neutral Europe. https://ec.europa.eu/energy/sites/ener/files/hydrogen_strategy.pdf.

174 For example, Hydrogen Europe’s “A 2x40 GW initiative” contains a Roadmap to 40 GW electrolyser capacity in North-Africa and Ukraine by 2030. <https://www.hydrogen4climateaction.eu/2x40gw-initiative>.

175 Blue’s the colour: Equinor and Gassco set sights on huge Norway hydrogen export pipeline. <https://www.upstreamonline.com/energy-transition/blues-the-colour-equinor-and-gassco-set-sights-on-huge-norway-hydrogen-export-pipeline/2-1-964408>. <https://www.upstreamonline.com/energy-transition/blues-the-colour-equinor-and-gassco-set-sights-on-huge-norway-hydrogen-export-pipeline/2-1-964408>.

176 <https://www.gazprom.com/press/news/2021/march/article525372/>

177 Including BNEF: Hydrogen Project Valuation (H2Val) Model; Agora-AFRY: No-regret hydrogen; Florence School of Regulation: Clean Hydrogen Costs in 2030 and 2050; IRENA (2020), Green hydrogen cost reduction.

TABLE 3

Renewable energy production and electricity consumption assumptions for Ukraine and North Africa

Region	Parameter	Assumptions
Ukraine	Solar PV	<ul style="list-style-type: none"> – Technical potential: 800 GW ¹⁷⁸ – Capacity factor: 19% ¹⁷⁹ – Deployment rate: 10% in 2030, 20% in 2040, 50% in 2050¹⁸⁰
	Onshore wind	<ul style="list-style-type: none"> – Technical potential: 320 GW ¹⁸¹ – Capacity factor: 35% ¹⁷⁹ – Deployment rate: 10% in 2030, 25% in 2040, 60% in 2050¹⁸⁰
	Final electricity demand	– 170 TWh in 2030, 193 TWh in 2040, 210 TWh in 2050 ¹⁸²
Morocco & Algeria	Solar PV	<ul style="list-style-type: none"> – Technical potential: 1000 GW ¹⁸³ – Capacity factor: 30% ¹⁷⁹ – Deployment rate: 10% in 2030, 25% in 2040, 60% in 2050¹⁸⁰
	Final electricity demand	– 102 TWh in 2030, 134 TWh in 2040, 165 TWh in 2050 ¹⁸²

As shown in Figure 29, we estimate that:

- By 2030, up to 60 TWh of dedicated green hydrogen can be produced in North Africa and Ukraine at production costs of 2.0 €/kg or less, of which around 45 TWh from North African solar PV available at production costs of 1.35 €/kg.
- By 2040, North Africa and Ukraine have the potential to produce and export more than 500 TWh of green hydrogen, at average production costs well below 2.0 €/kg. This includes around 330 TWh from dedicated solar PV plants in North Africa at costs of 1.0 €/kg and 170 TWh of hydrogen from Ukrainian solar PV and wind.
- By 2050, green hydrogen export potential in North Africa and Ukraine increases to around 1,700 TWh. Almost all of this volume can be produced at costs below 1.5 €/kg, with up to 1,000 TWh of export potential from solar PV-based hydrogen from North Africa available at production costs of 0.80 €/kg.

As with domestic (European) green hydrogen production, a range of factors need to be considered in addition to the production costs presented above. In the case of Morocco and Algeria, these countries will need to first and foremost address the needs of their growing populations and economies. In “Towards a comprehensive Strategy with Africa”, the European Commission notes that Africa as whole will need to double its energy supply by 2040 while ensuring access to electricity for its 600 million inhabitants. This means putting the focus on resilient infrastructure, cleaner, more sustainable and secure energy access, maximising renewable energy sources, energy transition and efficiency across all value chains, as well as regional integration for energy security. Although North Africa can be a potential supplier of cost-competitive green hydrogen to the EU, this should not come at the expense of other priority policy objectives.

Furthermore, as discussed previously in Section 3.2, regional freshwater availability must be analysed to ensure that local water supplies are not depleted for electrolysis. Where needed, costs of desalination facilities, as a possible source for freshwater, need to be taken into account in the full delivery price of hydrogen from North Africa. Finally, the above estimates do not yet include costs for long-distance hydrogen transport, nor do they include the costs of storage for firming variable renewable energy generation.

¹⁷⁸ SolarPower Europe, 100% Renewable Europe. https://www.solarpowereurope.org/wp-content/uploads/2020/05/SolarPower-Europe-LUT_100-percent-Renewable-Europe_Summary-for-Policymakers_mr.pdf.

¹⁷⁹ <https://www.renewables.ninja/>.

¹⁸⁰ Guidehouse assumption.

¹⁸¹ IRENA (2017). Cost-competitive renewable power generation: Potential across South East Europe. <https://www.irena.org/publications/2017/Jan/Cost-competitive-renewable-power-generation-Potential-across-South-East-Europe>.

¹⁸² International Energy Agency for current demand, extrapolation assumption by Guidehouse.

¹⁸³ Fraunhofer Institute for Solar Energy Systems (2016). Supergrid – Approach for the integration of renewable energy in Europe and North Africa.

FIGURE 29

Supply-cost curve of green hydrogen supply potential from outside Europe in 2030, 2040, and 2050

■ Wind onshore
■ Solar PV

2030

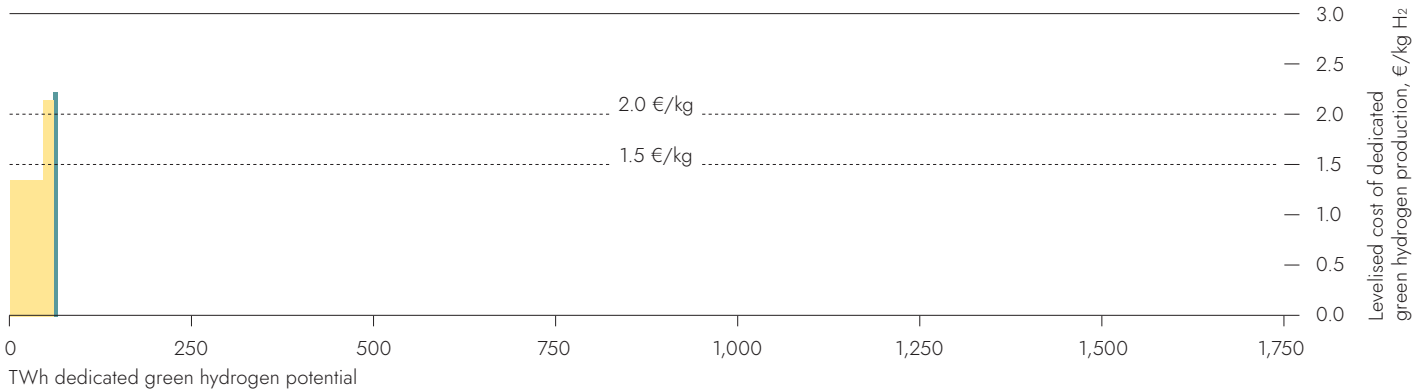

2040

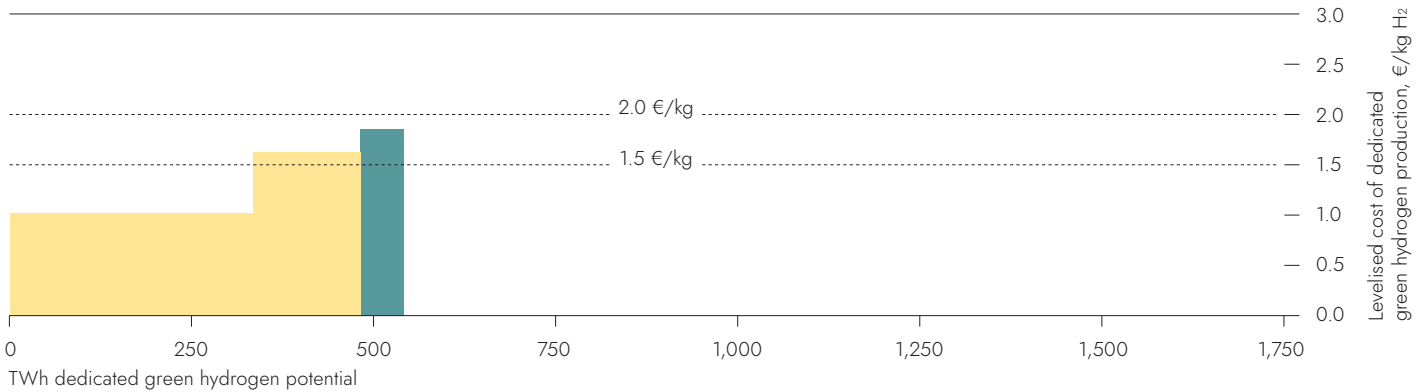

2050

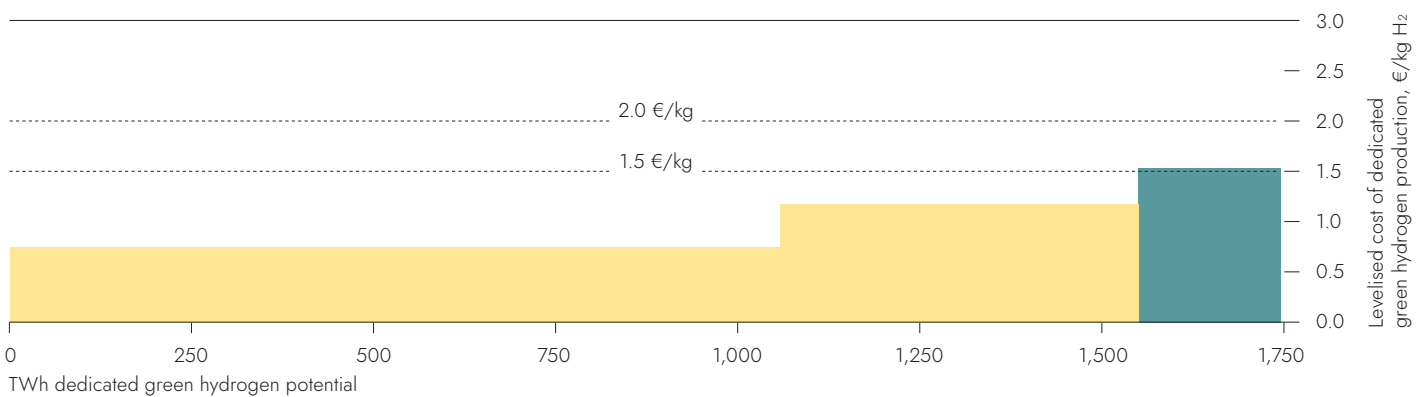

Source: Guidehouse analysis

Each volume 'slice' on the x-axis represents green hydrogen production potential—after considering the needs of the electricity market—in Ukraine and North Africa.

In spite of these factors, the favourable economics of pipeline imports from these neighbouring regions, driven by abundant natural resources and physical proximity, make them attractive partners for future hydrogen trade. With long-distance pipeline transport costs estimated at 0.09-0.16 €/kg/1000km for 48-inch pipelines as shown in Figure 30 in Section 4.1, the transport component only weighs marginally on the final delivery cost of hydrogen when considering production costs of 1.0 €/kg or less. This means that importing hydrogen by pipeline presents a viable strategy to complement domestic EU+UK production, in particular in 2040 and 2050 and to a lesser extent in 2030.

4. Hydrogen Transport Infrastructure

- Hydrogen pipelines are the most cost-efficient option for long-distance, high-volume transport of hydrogen to connect hydrogen supply regions with demand clusters within the EU+ UK. The EHB is estimated to cost €0.11-€0.21/kg/1,000 km on average, outcompeting transport by ship for all reasonable distances within Europe and between Europe and potential neighbouring export regions.
- Cost-efficient hydrogen transport by pipeline enables hydrogen imports from neighbouring regions such as North Africa, Ukraine, Norway, and potentially the Middle East – where renewable energy is abundant and cheap – to complement domestic hydrogen production and to support the security of European supply.
- All shipping methods – ammonia, LOHC, and LH₂ – have high upfront costs, related to conversion and reconversion installations and in the case of LOHC the carrier chemical costs. Ship-transport is three to five times more expensive compared to pipeline transport when looking at north-Africa and Saudi Arabia. For imports from Australia pipelines are not an option and ship-transport costs are estimated to be around €1/kg of H₂.
- Hydrogen pipelines and electricity networks each possess their complementary strengths when it comes to long-distance transport of decarbonised energy carriers. The cost-optimal energy transport option depends on factors such as the desired end-use energy carrier, availability and cost of storage, renewable energy supply characteristics, and network topology. For high-volume transport of energy when the desired end-product is hydrogen, pipelines – both newly built and repurposed ones – are 2 to 4 times more cost-effective than power lines. This comparison excludes storage costs for electricity and hydrogen.
- The consideration between gas and electricity transport is not only an economic question but also one of societal acceptance. Whereas a 48-inch hydrogen pipeline can have a throughput capacity of up to 16.9 GW, power lines typically possess throughput capacities in the range of 2 to 3 GW each. This means that, to transport volumes of energy corresponding to a 48-inch pipeline (the size that is used today with natural gas) using power lines would require the equivalent of 5 to 9 overhead transmission lines.

4.1. Hydrogen Transport by Pipeline

A hydrogen pipeline network would be comprised of essentially the same components as natural gas pipelines are operated today, assuming hydrogen storage will be as widely available as natural gas storage is today. Gas pipelines have various diameters, typically 20-48 inch at the transmission level, depending on the market characteristics of the region being served by the pipeline. Transmission pipelines are operated at different pressures, typically between 50-80 bar. Larger diameters and higher pressures allow pipelines to provide higher throughputs.

Hydrogen has different properties than natural gas that must be taken into account when designing or repurposing a pipeline network. At high pressures, hydrogen can over time cause localized embrittlement when in contact with bare steel. But oxide layers prevent contact between hydrogen and steel. Minimizing fluctuations in operating pressure can also prevent hydrogen embrittlement. Hydrogen is also a smaller molecule than methane and is more prone to leakage and permeation. Hence, repurposing existing natural gas pipelines into dedicated hydrogen pipelines requires integrity assessments to be conducted concerning the potential presence of crack-like defects and tightness-related modifications of valves and fittings. Depending on the state of the existing infrastructure, repurposed pipelines may need to be operated at lower pressures to ensure compliance with existing engineering codes. Furthermore, different driver and compressor designs will likely be required for hydrogen, meaning existing compressors cannot be repurposed. This is because hydrogen’s low molecular weight would require most existing centrifugal compressors to rotate three times as fast in order to achieve the same level of compression.^{184,185} Repurposing natural gas infrastructure for use with hydrogen is technically feasible, at a modest cost compared to the construction of new pipelines, although exact costs of repurposing are subject to more detailed engineering studies and – where compression is needed – replacement of compressors and potentially drivers will be required.

The major cost components of a gas pipeline are the pipeline CAPEX, compressor CAPEX, and the electricity required to power the compressors. European gas TSOs conducted hydraulic simulations to determine the throughput and compression power for the following three common natural gas pipeline configurations in Europe: – 48-inch and 80 bar, 36-inch and 50 bar, and 20-inch and 50 bar. Simulations were performed for 100%, 75%, and 25% of the theoretical maximum throughput capacity to determine how compression needs vary with throughput. Table 4 summarises the throughputs corresponding to each modelled pipeline scenario.

TABLE 4

Maximum theoretical throughput of pipelines at different % capacities¹⁸⁶

Pipeline Diameter and Pressure	100% Capacity	75% Capacity	25% Capacity
48-inch, 80 bar	16.9 GW	12.7 GW	4.2 GW
36-inch, 50 bar	4.7 GW	3.6 GW	1.2 GW
20-inch, 50 bar	1.2 GW	0.9 GW	0.3 GW

The hydraulic simulations were then used to estimate the levelised cost of transport for new and repurposed pipelines. The analysis assumes all pipelines operate 5,000 full load hours, which is a typical average for natural gas transmission pipelines¹⁸⁷. Note that in practice load factor is a product of many factors such as fluctuations in demand, use of storage, and network configuration. Furthermore, intermittent load profiles from electrolysers will require hydrogen pipelines to have dynamic capacities. Figure 30, Figure 31, and Figure 32 show the levelised transport cost breakdown for 48-inch, 36-inch, and 20-inch pipelines respectively at 100%, 75%, and 25% utilisation.¹⁸⁸ Note that 25% utilisation factor is below the typical operational range for pipelines, however results are included here to illustrate the impact on costs during early stages of network development before expected flows are reached. Levelised costs for 20-inch pipelines are in €/kg/200 km because they are typically used for shorter distances than larger diameter pipelines due to their low throughput and higher levelised cost.

184 <https://www.energy.gov/eere/fuelcells/gaseous-hydrogen-compression>

185 More detailed cost assumptions can be found in Appendix C.1. Hydrogen Transport by Pipeline

186 Dynamic operation of pipelines required to balance the energy system can significantly decrease throughput in practice. Available at https://gasforclimate2050.eu/sdm_downloads/extending-the-european-hydrogen-backbone/

187 Full load hours vary depending on geography due to country-specific network factors.

188 More detailed cost assumptions can be found in Appendix C.1. Hydrogen Transport by Pipeline

FIGURE 30

Breakdown of levelized cost of new and repurposed 48-inch pipelines operating at 100% capacity, 75% capacity, and 25% capacity

- Pipe OPEX (€/kg/1000 km)
- Pipe CAPEX (€/kg/1000 km)
- Compressor OPEX (€/kg/1000 km)
- Compressor CAPEX (€/kg/1000 km)

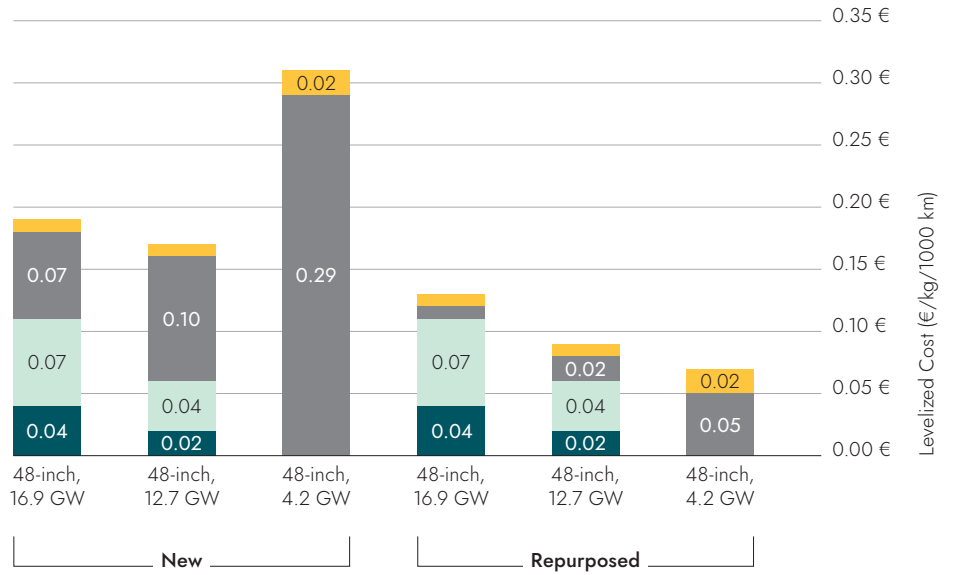

FIGURE 31

Breakdown of levelized cost of new and repurposed 36-inch pipelines operating at 100% capacity, 75% capacity, and 25% capacity

- Pipe OPEX (€/kg/1000 km)
- Pipe CAPEX (€/kg/1000 km)
- Compressor OPEX (€/kg/1000 km)
- Compressor CAPEX (€/kg/1000 km)

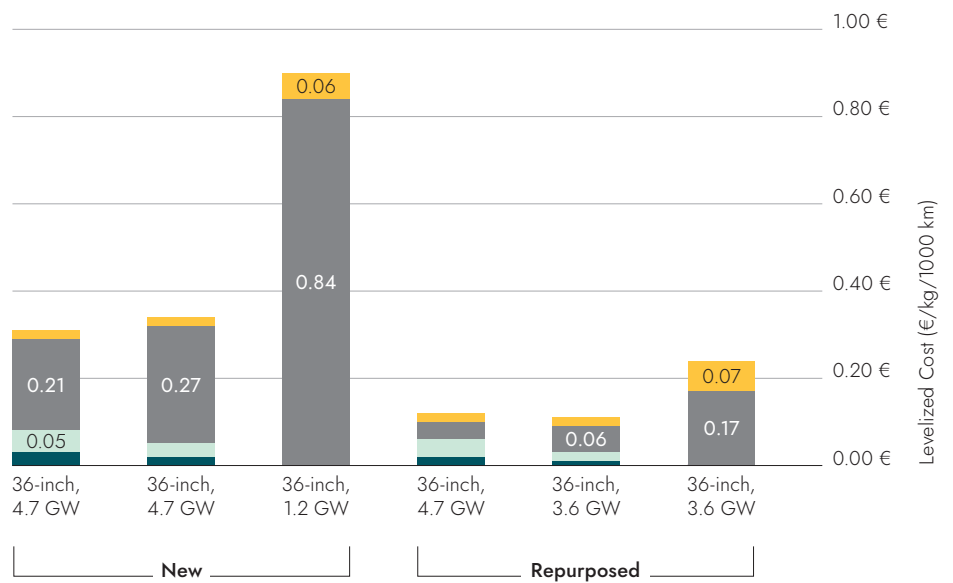
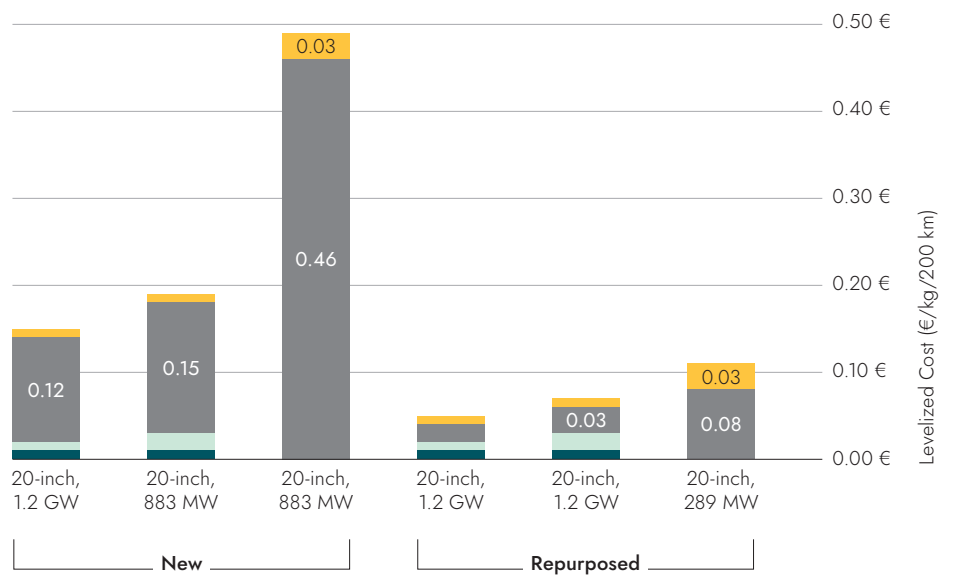

FIGURE 32

Breakdown of levelized cost of new and repurposed 20-inch pipelines operating at 100% capacity, 75% capacity, and 25% capacity

- Pipe OPEX (€/kg/200 km)
- Pipe CAPEX (€/kg/200 km)
- Compressor OPEX (€/kg/200 km)
- Compressor CAPEX (€/kg/200 km)



Source: Guidehouse analysis

“Beginning of 2021 more than 30 European energy players launched “HyDeal Ambition” with the aim of delivering 100% green hydrogen from solar power on the Iberian Peninsula and in Northern Africa at €1.5/kg before 2030. As DH2 Energy, a developer of mass-scale solar projects dedicated to hydrogen production we are part of this initiative. Our goal requires a hydrogen transmission and storage network that connects green hydrogen produced in Southern Europe (and other potential sources) with customers across Europe. The European Hydrogen Backbone is a key enabler for us.”

Thierry Lepercq
President and Co-founder
DH2 Energy

Smaller diameter pipelines have lower unit capital costs than larger diameter pipelines, however they have higher costs per kg transported due to their lower throughput. Large, high-pressure pipelines, while more affordable from a levelised cost perspective, require larger safety distances from civilization, which may complicate routing. Several factors must be considered when planning pipeline routes and associated diameters and pressures. For new 48-inch pipelines at 80 bar and repurposed 36-inch pipelines at 50 bar, compressor power is a significant expense, and operating the pipeline at 75% capacity lowers the compressor power sufficiently to lower the overall levelised cost. Further cost optimisation can likely be performed to maximize throughput while lowering compressor power to determine the optimal capacity to operate these pipelines at. Repurposed 48-inch pipelines are cheaper to operate at 25% than 75% capacity. This presents a cost-effective transport option in early years when hydrogen flows are modest and infrastructure is gradually developed. However, in later years after the industry has scaled, it is likely that operating a pipeline at such a low capacity would require building additional pipeline capacity to meet demand. As hydrogen flows ramp up, throughput can be increased to a more appropriate level by constructing additional compression capacity. For new 36-inch pipelines at 50 bar and new and repurposed 20-inch pipelines at 50 bar, pipeline CAPEX is a much larger cost than compressor OPEX per unit of hydrogen transported, so operating at maximum throughput is optimal from a levelised cost perspective.

It is important to note that hydraulic simulations performed for this cost analysis modelled a 1,000 km pipeline stretch with no branching or off-takers. They do not incorporate a scenario-based simulation of a full-scale network as is commonly done for network development planning. In reality, the backbone will be a complex, meshed pipeline grid with many branches, off-takers, and changes in pipeline diameter and pressure, and these differences will influence the overall cost of the backbone and lead to locational differences in levelised costs. Furthermore, required hydrogen capacity and load factor are expected to shift over time as a result of changing market dynamics, having both positive and negative impacts on the cost estimate. However, by taking an infrastructure-driven view (as opposed to designing for a specific system demand) and by selecting a generic network design for the analysis, the resulting parameters and cost ranges are deemed representative of the EU+UK average.

In creating the EHB maps, participating gas TSOs were consulted to determine the lengths and diameters of pipelines in their country's proposed hydrogen network. The backbone will consist of a wide variety of diameters, pressures, and will consist of new pipelines and repurposed natural gas pipelines. Pipelines were grouped into large, medium, and small pipelines. The 2040 backbone is comprised of 46% large pipelines, 42% medium pipelines, and 12% small pipelines¹⁸⁹. Furthermore, 69% of the backbone is repurposed. When estimating the total cost, large pipelines were modelled as 48-inch pipelines at 80 bar, medium pipelines as 36-inch pipelines at 50 bar, and small pipelines as 20-inch at 50 bar. The average levelised cost of the backbone was determined to be €0.11-€0.21/kg/1,000 km (€3.6-€7.0/kWh/1,000 km) by weighting the length and capacity of each pipeline size, new and repurposed.

189 Guidehouse (2021): Extending The European Hydrogen Backbone. Available at https://gasforclimate2050.eu/sdm_downloads/extending-the-european-hydrogen-backbone/

4.2. Hydrogen Transport by Ship

Hydrogen has a low energy density, which makes it challenging to transport economically by ship. However, several methods of shipping are being investigated, and this study examines three of the most promising:

1. liquid hydrogen,
2. liquid organic hydrogen carriers (LOHCs)
3. ammonia.

All three shipping methods involve converting gaseous hydrogen into a more energy dense liquid so that more energy can be transported. The shipping process can be broken down into seven steps: 1) pipeline from the hydrogen production site to the export terminal, 2) conversion of gaseous hydrogen into the shipping medium, 3) storage at the import terminal, 4) shipping, 5) storage at the export terminal, 6) reconversion to gaseous hydrogen, and finally the 7) pipeline to the demand location.

Liquid hydrogen: Hydrogen has a boiling point of $-253\text{ }^{\circ}\text{C}$, so liquefying gaseous requires substantial compression and cooling. This process consumes the equivalent of roughly one third of hydrogen's energy content but increases the volumetric energy density by a factor of more than 10 compared to gaseous hydrogen at 80 bar. Storage and transport containers for the liquid hydrogen must be very well insulated to minimise the amount that boils off. The hydrogen is shipped on a vessel similar to an LNG tanker. A portion of the boil-off can be used as fuel for the ship, however the remaining boil off is flared to the environment in order to limit the pressure build up inside the tank and prevent rupturing. Methods of reducing and eliminating boil-off have been investigated, such as using tanks that can withstand higher pressures or having a reliquefaction system onboard the ship. However, neither of these methods have been demonstrated to be cost-effective.¹⁹⁰

LOHCs refer to organic chemicals that reversibly react with hydrogen to form chemicals that can be easily transported by ship. Good candidates are relatively non-toxic, inexpensive, capable of "storing" large quantities of hydrogen, have relatively low temperature conversion and reconversion reactions, and can withstand many cycles. The most promising LOHC candidates are derivatives of toluene.¹⁹¹ Toluene can be reacted with hydrogen to produce methylcyclohexane, which can be shipped and then reconverted into hydrogen and toluene. LOHC shipping typically consumes more fuel than the other two methods because the LOHC is heavier than ammonia or hydrogen and must be shipped back after reconversion, meaning that the ship contains a full load each way and cannot transport a different cargo on the return trip. The ship must also have a carbon-neutral fuel such as hydrogen, ammonia, or a synfuel to propel the ship since the cargo cannot be used as fuel without producing GHG emissions. Finally, the LOHC itself represents an additional cost because it must be purchased and replaced as it degrades – approximately 0.1% is lost every conversion/reconversion cycle.

Ammonia involves the reaction of gaseous hydrogen with gaseous nitrogen to form ammonia via the Haber-Bosch process, one of the most widely used chemical processes on the planet. Ammonia has a boiling point of $-33\text{ }^{\circ}\text{C}$, so ammonia shipping vessels must be insulated to keep the ammonia in liquid form, however boil-off is a much smaller concern for liquid ammonia than liquid hydrogen. As in liquid hydrogen shipping, ammonia can be used to fuel the ship, and fuel demand is higher than the boil-off rate, so excess boil-off is not a concern. However, cracking (reconversion) of ammonia back to nitrogen and hydrogen is relatively inefficient and not yet proven at scale. An advantage to ammonia shipping is that ammonia

190 Al-Breiki and Bicer (2020). Comparative cost assessment of sustainable energy carriers produced from natural gas accounting for boil-off gas and social cost of carbon. <https://www.sciencedirect.com/science/article/pii/S2352484720312312>.

191 Hurskainen and Ihonen (2020): Techno-economic feasibility of road transport of hydrogen using liquid organic hydrogen carriers. <https://www.sciencedirect.com/science/article/pii/S0360319920332134>

is already internationally traded so the shipping infrastructure already exists and is proven. Another advantage is ammonia is a widely used chemical in and of itself, so not all of the delivered ammonia necessarily needs to be reconverted to hydrogen. Ammonia shipping may be able to benefit from the scale of combined ammonia and hydrogen demand. This analysis considers hydrogen as an energy carrier, and reconversion of ammonia to hydrogen remains inefficient and unproven at scale.

For all three shipping methods, the fixed costs related to conversion and reconversion are the most significant portions of the total shipping cost, making up between 60 to 80% of total transport costs for a 10,000 km journey. The marginal cost increase per km shipped is relatively minor, so longer distances make the case for shipping stronger. Figure 33 breaks down the levelized cost of each shipping method assuming an illustrative 10,000 km route and 100 km pipelines from the production site to the export terminal and from the import terminal to the demand site. Liquid hydrogen and ammonia ships are modelled to return to their origin empty, though dual-use ships may be possible.¹⁹²

FIGURE 33
Levelized shipping cost breakdown for liquid hydrogen, LOHC, and ammonia over 10,000 km¹⁹³

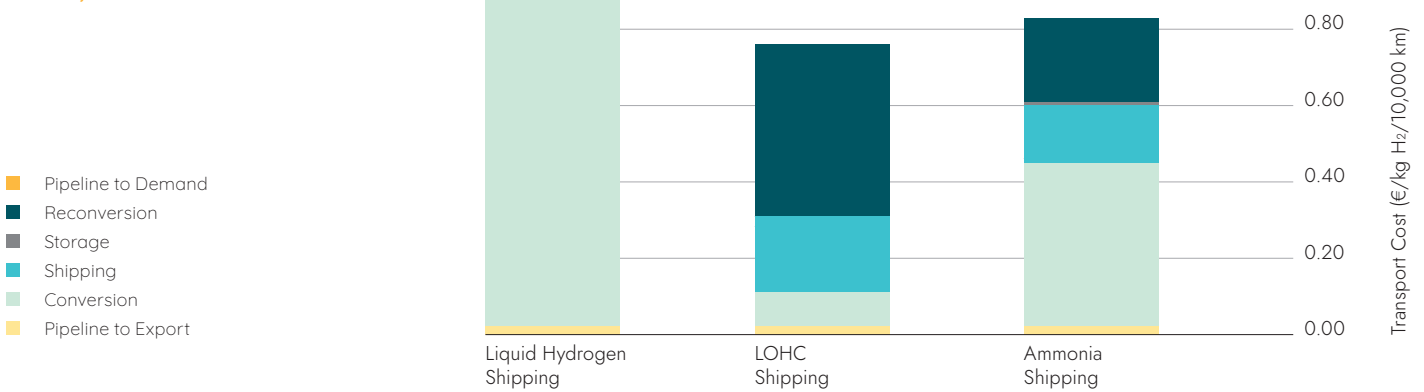

Source: Guidehouse analysis

We estimate that transporting hydrogen by ship costs €0.78-€1.31/kg/10,000 km. This is an optimistic cost projection that assumes significant scale-up and technology development that will not be available in the near future. Please see Appendix C. for more details on our approach and unit costs. We estimate that liquid hydrogen shipping is the most expensive option due to the large amount of energy required to liquefy the hydrogen. LOHC and ammonia shipping are similar in cost, with LOHC being slightly less expensive though less mature. It is worth noting however that for liquid hydrogen shipping the most energy intensive step – liquefaction – takes place in the export country, and little energy is required to gasify it in the import country. It is likely that the export country is exporting hydrogen because of an abundance of very cheap renewable electricity. If energy in the export country is sufficiently cheaper than that in the import country, the case for liquid hydrogen shipping over ammonia or LOHC shipping may become stronger.

192 Forbes (2019): Dual Use LNG Shipping: A Gamechanger For Carbon Management? <https://www.forbes.com/sites/uhenergy/2019/02/28/dual-use-lng-shipping-a-gamechanger-for-carbon-management/?sh=3ff5387e1f47f>

193 Storage at import and export terminals is combined into one figure. Pipeline figures include both pipeline and compressors. Import and export pipelines are combined into one figure for shipping options.

4.3. Comparison of Hydrogen Transport Methods and Supply Routes

Figure 34 compares the cost of shipping versus pipeline over various distances. All three shipping methods are compared with new and repurposed 48-inch and 36-inch pipelines, as well as the average levelised European Hydrogen Backbone cost presented in section 4.2.¹⁹⁴

FIGURE 34
Comparison of hydrogen transport options over various distances

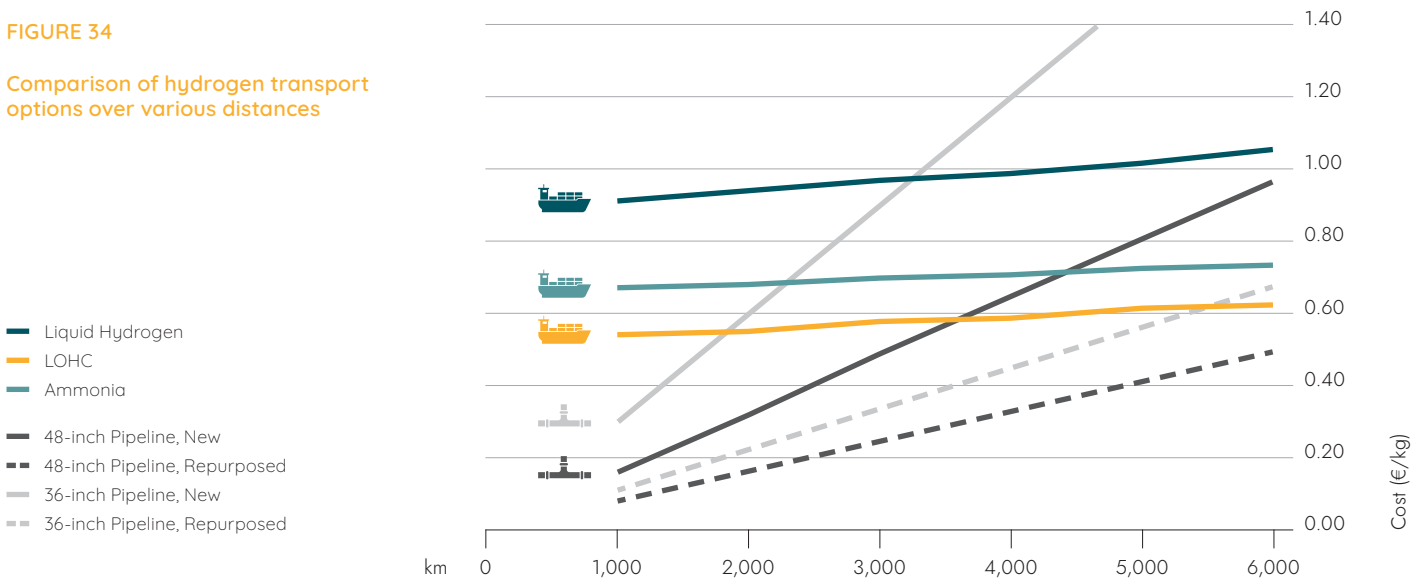

Source: Guidehouse analysis (see Appendix C for assumptions)

For all possible hydrogen transport routes within or near Europe that can be served by pipeline, a pipeline is a more cost-effective option than any shipping method, assuming sufficient volumes are being transported to justify a pipeline at least 36 inches in diameter because pipelines with higher throughputs are less expensive. Shipping should be reserved for long distance, intercontinental trade separated by ocean. Shipping is also advantageous from the perspective of security and flexibility of supply. Pipelines can be difficult to construct across politically unstable regions, and shipping routes can be modified to react to changes in market dynamics. When hydrogen is shipped, export and import locations should be selected as close to the production and demand sites as possible because the marginal cost of shipping per km is lower than that of pipelines.

To illustrate a real-world comparison between pipeline and shipping, we examined two promising import routes into Europe that could use pipeline or shipping: (1) North Africa to Northern Europe and (2) Saudi Arabia to Southeast Europe. Figure 35 displays these routes. Note that this analysis is not intended to provide an exhaustive list of potential export regions, nor does it make any claims about which exporters are more likely or favourable. The two routes were chosen to compare shipping costs to pipeline costs simply because the distances travelled by ship and pipeline would be similar. The routes displayed are illustrative.

¹⁹⁴ Average EHB cost is weighted by length and capacity of different pipeline diameters..

FIGURE 35

Map of example routes to compare shipping and pipelines as hydrogen transport methods

For imports from
(1) North Africa to Northern Europe and
(2) Saudi Arabia to Southeast Europe)

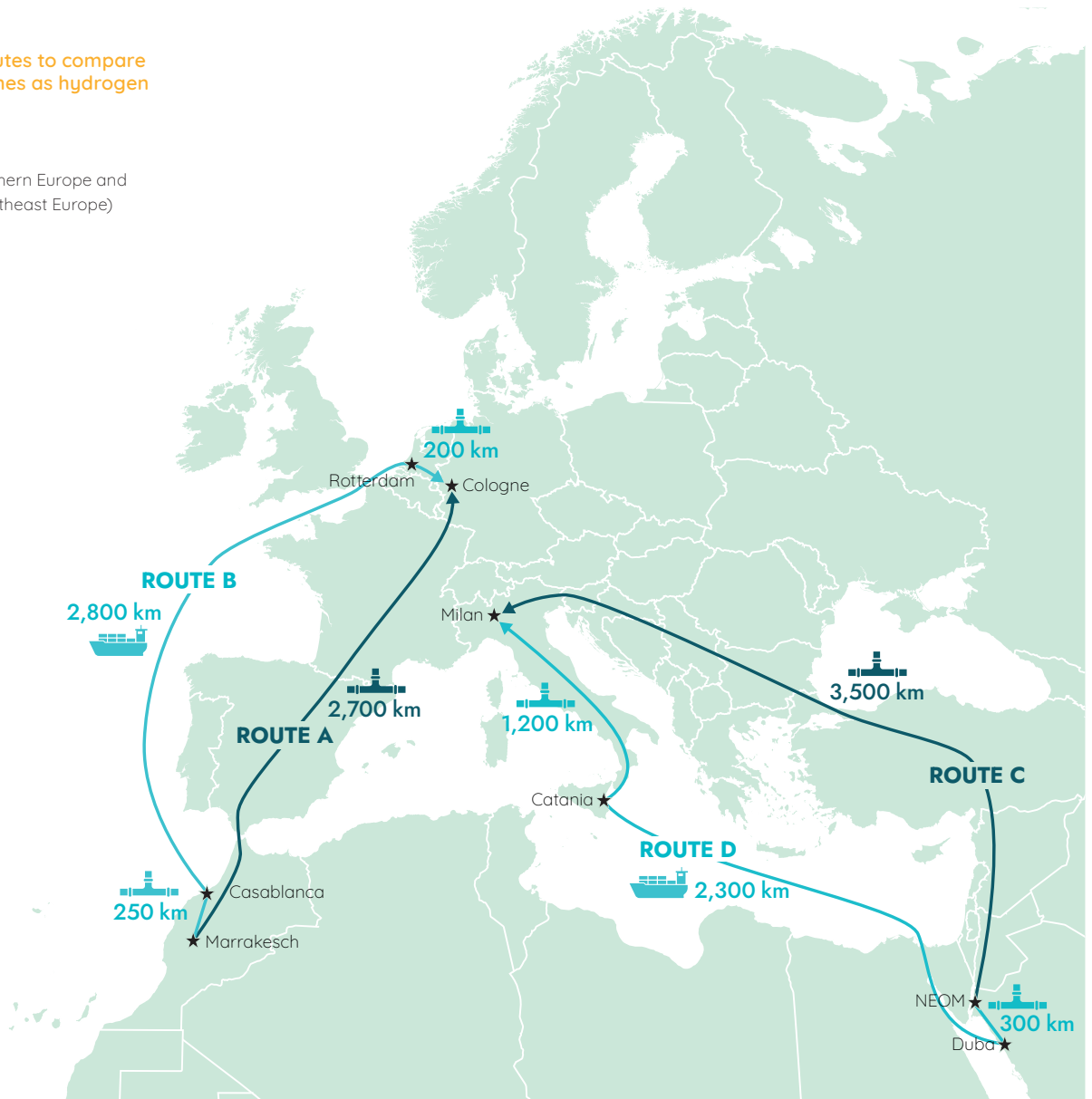

(1) Import from North Africa (Marrakech) to Northern Europe (Cologne):

North Africa has excellent wind and solar resources and large amounts of suitable land to build renewable energy generation on. This region has potential to become an exporter of very cheap renewable energy and is in close proximity to Southern Europe. Furthermore, Morocco is only narrowly separated from Spain by the Mediterranean Sea, so a subsea pipeline can be constructed to bridge the gap. There is also an existing sub-sea natural gas pipeline between Morocco and Spain that could be repurposed for hydrogen in the future.

As an illustrative exercise, Marrakech was selected as a representative location of hydrogen production and Cologne was selected as a representative location of hydrogen demand. (Route A) A pipeline route from Marrakech to Cologne (2,700 km) was compared to (Route B) a shipping route involving a pipeline from Marrakech to Casablanca (250 km), ship from Casablanca to Rotterdam (2,800 km), and pipeline from Rotterdam to Cologne (200 km). Figure 36 compares the costs of the various transport options.

FIGURE 36

Transport cost comparison for North Africa to Northwest Europe

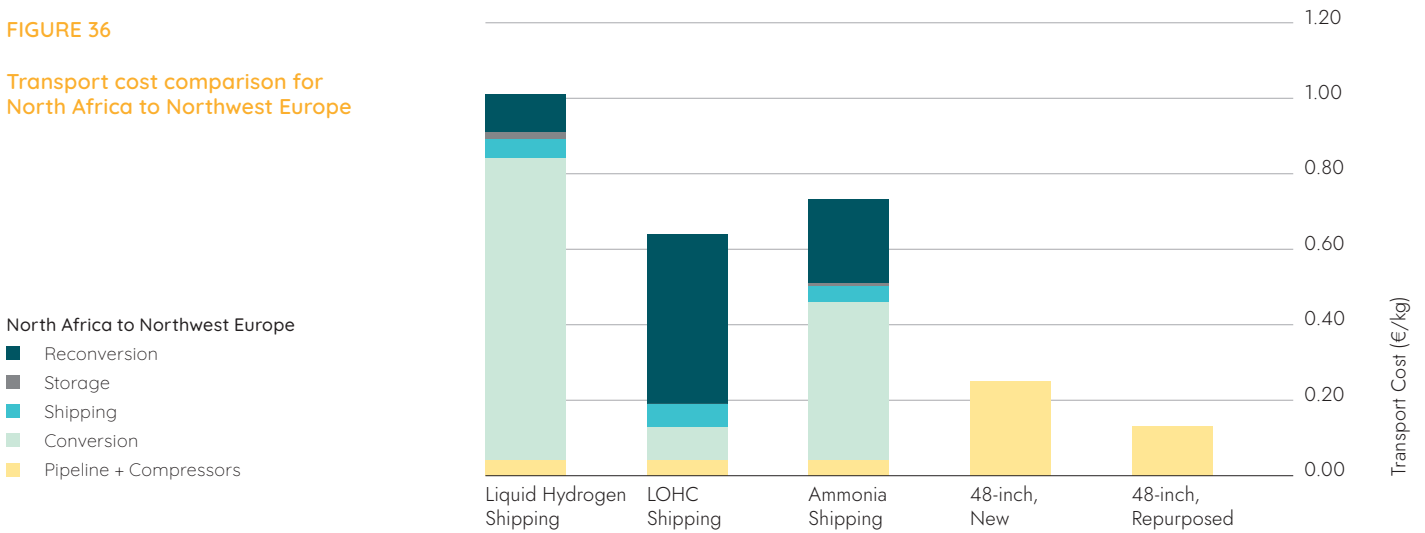

Pipeline is by far the most cost-effective of the three options, adding 0.13-0.25 €/kg hydrogen delivered for 48" pipelines compared to 0.65-1.03 €/kg hydrogen for the shipping options. It is worth noting that no sub-sea hydrogen pipelines have been developed to date. Sub-sea natural gas pipelines are often operated at higher pressures and use thicker steel because it is challenging to compress the gas along the stretch of pipe that is underwater, and it is uncertain whether hydrogen pipelines can be safely and effectively operated at pressures higher than 80 bar. However, the Strait of Gibraltar is 13-43 km across, so elevated pressures are likely unnecessary to ensure that the hydrogen is transported effectively across the Mediterranean Sea. The pipeline diameter and admissible pressure to operate the pipeline safely will determine the transport capacity.

(2) Import from Saudi Arabia (NEOM) to Southeast Europe (Milan):

Saudi Arabia, like North Africa, has excellent renewable generation potential, is close to Europe, and transport can largely take place over land or sea, depending on the selected route. The country is therefore a potential hydrogen exporter and a good candidate to compare transport options. NEOM was selected as the representative production site and Milan was selected as the representative demand site. (C) A pipeline from NEOM to Milan (3,500 km) was compared to (D) a shipping route including a pipeline from NEOM to Duba (300 km), ship from Duba to Sicily (2,300 km), and a pipeline from Sicily to Milan (1,200 km) Figure 37 compares the cost of the different transport options.

FIGURE 37

Transport cost comparison for Saudi Arabia to Southeast Europe

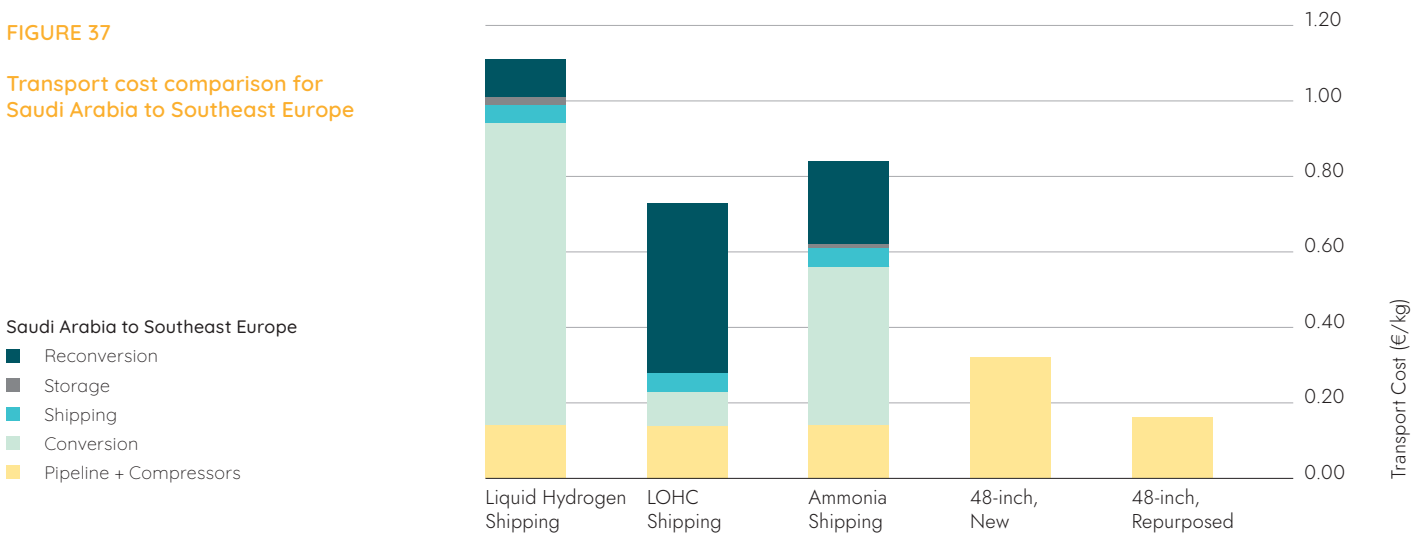

The shipping options are more competitive for this route because the distance is greater, however pipeline is still significantly more cost-effective than any of the shipping options. Pipeline route C shown in Figure 35 is almost entirely land-based, however it would be possible to build a shorter pipeline by routing part of it under the Mediterranean Sea. As previously mentioned, sub-sea pipelines for hydrogen do not currently exist and R&D is required to determine if they can be safely and effectively operated at the elevated pressures required. Assuming that a hydrogen pipeline under the Mediterranean Sea is possible, experience with natural gas pipelines suggests that constructing a new sub-sea pipeline would be approximately 60% to 100% more expensive than an onshore pipeline.^{195, 196} Most of the additional expense associated with constructing sub-sea pipelines is related to the difficulties of working underwater, rather than materials. For this reason, it is likely that incremental savings from repurposing sub-sea natural gas pipelines for hydrogen are less than those from repurposing pipelines on land.

Australia was examined as a third potential exporter of hydrogen due to its renewable generation potential and vast landmass. A shipping route was modelled including a 100 km pipeline to Melbourne, a shipping route from Melbourne to Sicily (16,000 km), and a pipeline from Sicily to Milan (1,200 km). Pipeline is obviously an unrealistic transport method for this route, while shipping transport costs from Australia can be compared to those from other potential exporters.

Figure 38 indicates that the cheapest mode of transport of hydrogen from Australia to Southeast Europe is LOHC shipping with a levelized cost of €1.00/kg. Assuming North African and Saudi hydrogen exports are available by pipeline, Australian hydrogen production would need to be €0.35/kg and €0.26/kg cheaper than North African and Saudi hydrogen production respectively for Australian exports to Europe to be competitive. It is unlikely for Australia to have such a significant hydrogen production cost advantage over two of the best locations on Earth to produce low-cost renewable energy. Furthermore, hydrogen is not supply constrained as discussed in Chapter 3. Hydrogen Supply. Therefore, intercontinental imports from regions such as Australia and Chile are unlikely to be economical, because they will have to compete with imports from nearby regions such as North Africa, Saudi Arabia, and Ukraine which can be transported to the European Union and UK at lower cost. Note that regions such as Australia may implement infrastructure necessary to export earlier than Ukraine or North Africa.

195 Brito and Sheshinski (1997). Pipelines and the Exploitation of Gas Reserves in the Middle East. http://large.stanford.edu/publications/coal/references/baker/studies/tme/docs/TrendsInMiddleEast_PipelinesExplorationGasReserves.pdf
 196 https://sari-energy.org/oldsite/PageFiles/What_We_Do/activities/GEMTP/CEE_NATURAL_GAS_VALUE_CHAIN.pdf

FIGURE 38
Australia to Southeast Europe

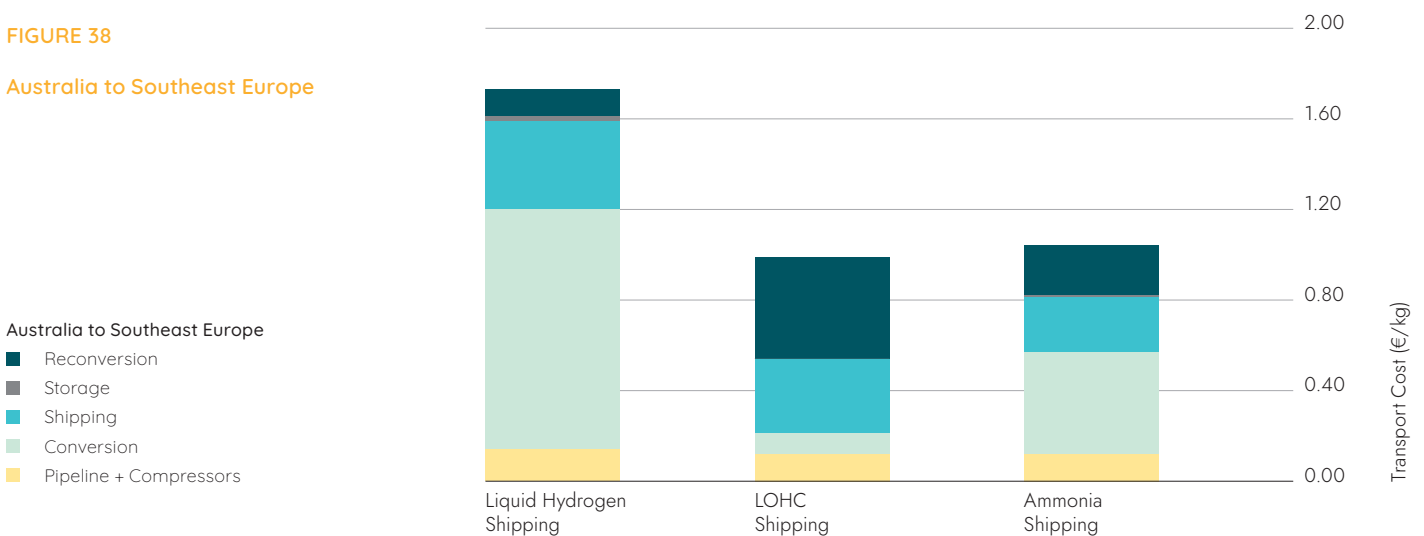

4.4. Comparison of Electricity and Hydrogen Infrastructure

4.4.1. Transport cost comparison between pipeline and power line

Conversion of electricity to hydrogen via electrolysis can occur near the site of electricity production or near the site of hydrogen demand. Sometimes it is asserted that instead of a hydrogen backbone, Europe could develop a more decentralised infrastructure, relying on a larger electricity network with electrolyzers placed strategically near clusters of hydrogen demand. Europe's hydrogen demand could still be met this way without transporting hydrogen over long distances. The presupposition herein is that electricity transport infrastructure is more cost-effective than hydrogen transport infrastructure and that a hydrogen delivery system based on decentralised electrolyzers is equally capable of meeting customers' hydrogen needs while maintaining adequate electricity supply.

To test the main drivers of long-distance power line transport costs, we examined three common types of electricity transmission infrastructure:

- 380 kV (2.8 GW) overhead HVAC lines,
- 525 kV (2.0 GW) underground HVDC lines, and
- 800 kV (8.0 GW) overhead HVDC lines.

It is worth noting that 800 kV (8 GW) overhead HVDC lines do not currently exist in Europe and face significant regulatory hurdles, particularly in Northwest Europe, where population densities are high. However, they are the most cost-effective electricity transmission method at long distances and are successfully used in other countries such as the U.S. and China, so are worth considering assuming the regulatory and permitting hurdles can be overcome. The cost of electricity transmission infrastructure was then compared to that of hydrogen pipeline infrastructure over various distances, assuming no branching or off-takers.

Wires were compared to pipelines assuming **hydrogen as the end-use** for both cases. If the energy is transported as hydrogen, electrolyser conversion losses occur before it is transported. However, if it is transported as electricity, electrolyser losses occur after transport, so the transmission infrastructure must be over-designed to compensate. 5000 full load hours were assumed for hydrogen pipelines. Utilisation of electricity transmission lines is typically lower, around 30-50%, so a 50% load factor (4380 full load hours) was assumed for electricity infrastructure.¹⁹⁷

Figure 40 shows that pipelines with a diameter of at least 36 inches with transport capacities of at least 3.6 GW, when operated at 5000 full load hours, are more cost-competitive than power lines at all distances analysed here. The most competitive electricity transmission option is 800 kV overhead HVDC, which does not currently exist anywhere in Europe, as stated above. Compared to these overhead HVDC power lines, new pipelines are more cost-effective for hydrogen demands of at least 4.7 GW (36-inch diameter) up to more than 2,500 km and at any distance for demands of 12.7 GW (48-inch).

¹⁹⁷ Load factor assumptions are consistent with *Energy Transitions Commission, Making the Hydrogen Economy Possible* (April 2021).

FIGURE 39

Comparison of electricity and hydrogen infrastructure costs for different distances assuming hydrogen as the end use for transported energy

- Overhead HVAC (2.8 GW)
- Overhead HVDC (8.0 GW)
- Underground HVDC (2.0 GW)
- 48-inch Pipeline, New
- 48-inch Pipeline, Repurposed
- 36-inch Pipeline, New
- 36-inch Pipeline, Repurposed

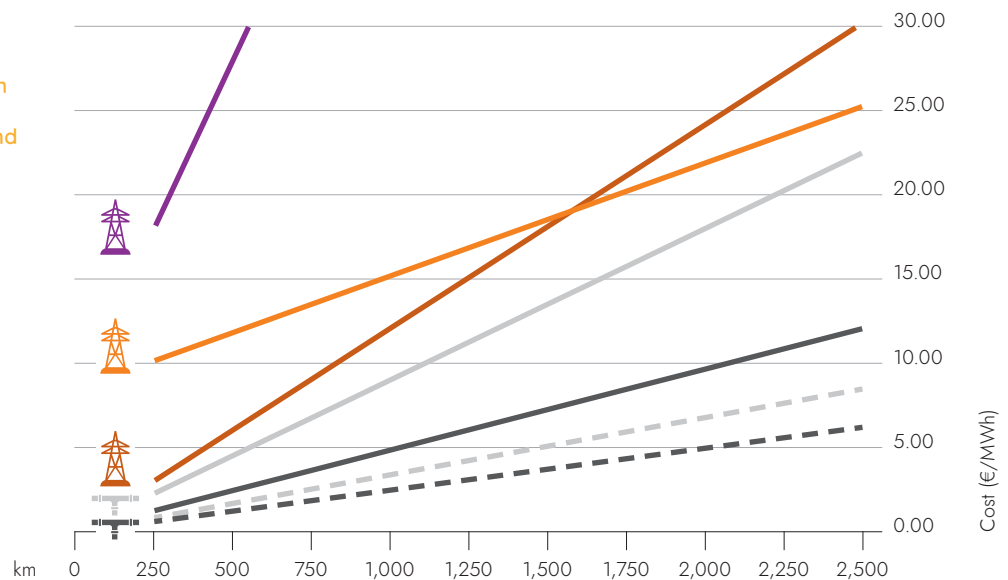

Source: Guidehouse analysis (see Appendix C for assumptions)

Both methods of energy transport have their benefits and trade-offs, yet the results show that for high-volume transport of energy when the desired end-product is hydrogen, pipelines – both newly built and repurposed ones and excluding storage costs – are 2 to 4 times more cost-effective than power lines.

It is important to note that this illustrative analysis, which serves to assess the cost drivers of pipeline and power line transport, makes several simplifying assumptions:

- First, the analysis assumes direct transportation from dedicated renewable generation to demand with no branching or off-takers, where the actual energy system is a complex network.
- Furthermore, the above analysis does not incorporate the effects or costs of storage, a crucial component to the energy system, or other balancing costs – which can be especially important in the electricity system. Without storage, most renewable projects, excluding offshore wind, are not be able to reach the 4380 to 5000 full load hours assumed in this calculation. Production of electricity from these projects varies dramatically, and periods of peak production produce significantly greater volumes than periods of average production. As a result, if electricity transmission infrastructure is built to deliver peak electricity production, it will be over-designed leading to low utilisation. Herein hydrogen infrastructure presents a promising solution. Electricity transmission infrastructure can be built to deliver the average electricity production, and the excess electricity during peaks can be converted and transported as hydrogen. Storage is also important in view of the fact that most energy customers require energy to be delivered at a relatively constant rate, which requires variable renewable electricity to be ‘shaped’ to meet demand. These storage costs, ranging between 5-20 €/MWh for hydrogen storage and 66-220 €/MWh for electricity storage,¹⁹⁸ need to be considered in addition to the point-to-point transport costs shown in Figure 40.
- When looking at offshore wind, where the 5000 full load hours are more realistic, additional grid investments will need to be considered including costs for the crossing of the dunes, offshore grid interconnections, and a premium for sea cables.

These factors point to areas of further work that will help improve the understanding of how electricity and hydrogen infrastructures can collaborate to create the most value to consumers, and how market design and policy can enable this.

198 Estimates taken from multiple sources: Agora: No regret Hydrogen (2021); Energy Transitions Commission (2021); R.K. Ahluwalia (2019); DNV-GL (2019); Lazard (2020); Schmidt et al. (2019).

4.4.2. Energy storage, system integration, and societal acceptance

The need for storage in a future decarbonised energy system is evident. Yet, electricity is challenging to store. The most common electricity storage technology today, batteries, are only capable of storing electricity on hourly timescales and are relatively expensive. This means that the utilisation of electricity infrastructure connected to dedicated large-scale renewable generation such as an offshore wind farm is essentially limited to the capacity factor of that wind farm. Furthermore, a purely electric system with significant intermittent renewable generation faces logistical challenges to match supply with demand on both an hourly and longer-term basis.

Gas on the other hand is easier to store. Operating pressures can be modulated to provide a few hours of storage from the capacity of the pipeline network alone – this is referred to as linepack.¹⁹⁹ Gas is stored in large geologic structures underground such as depleted gas fields, aquifers, and salt caverns at enormous volumes and for timescales as short as hours or as long as months. This storage enables constant delivery of energy to customers, balances seasonal differences in demand, limits pipeline throughput allowing for more efficient pipeline infrastructure investment, and provides insurance in periods of low energy production.

It has been demonstrated that hydrogen can be stored in salt caverns, and the latest research suggests that it can be stored in depleted gas fields and aquifers as well, though more R&D efforts are ongoing.²⁰⁰ Figure 41 below provides a comparison between the levelised cost of storing energy as hydrogen in salt caverns and as electricity using a range of storage technologies.

The overview in Figure 41 shows that the levelised cost of hydrogen storage in salt caverns, expressed in €/MWh, is significantly lower than the levelised cost of electricity storage. The highest estimate for hydrogen storage in salt caverns, 20 €/MWh, is still more than 3 times cheaper than the lowest estimate for a utility-scale battery system built specifically for supply-demand firming of renewables, reported at 66 €/MWh in Lazard's 2020 LCOS analysis. The difference is even greater when looking at averages. The average levelised cost of storage for hydrogen reported is around 9 €/MWh, compared to 115 €/MWh for electricity storage.

Moreover, the levelised cost of hydrogen storage adds a relatively small component to the overall cost of hydrogen delivered. At a levelised cost of 5-20 €/MWh, salt cavern storage would add between 8 and 33% to the cost of hydrogen delivery – assuming a production plus transport cost of 60 €/MWh (2 €/kg). This is a relatively small price to pay to firm up variable production profiles to meet the needs of industrial or power sector customers. In contrast, the levelised cost of battery storage is, at 66 €/MWh in the most optimistic case, equal to or perhaps more than the price of the commodity itself.

As with the pipeline network itself, an economic advantage of deploying hydrogen storage is that it would make use of existing assets and capabilities developed for natural gas storage in the past. As Europe decarbonises, natural gas flows will decrease, freeing up unused pipelines, storages, and other infrastructure for the delivery of hydrogen. This infrastructure can be converted for hydrogen use at lower cost than if it had to be built from scratch. Furthermore, the considerable overlap in use cases for natural gas and hydrogen means that much of the existing infrastructure and capabilities are already well-situated to meet hydrogen demand.

199 Linepack depends on the size, structure etc. of the pipeline network.

200 R. Tarkowski (2019). Underground hydrogen storage: Characteristics and prospects

FIGURE 40

Comparison between the levelised cost of storing energy as hydrogen and as electricity

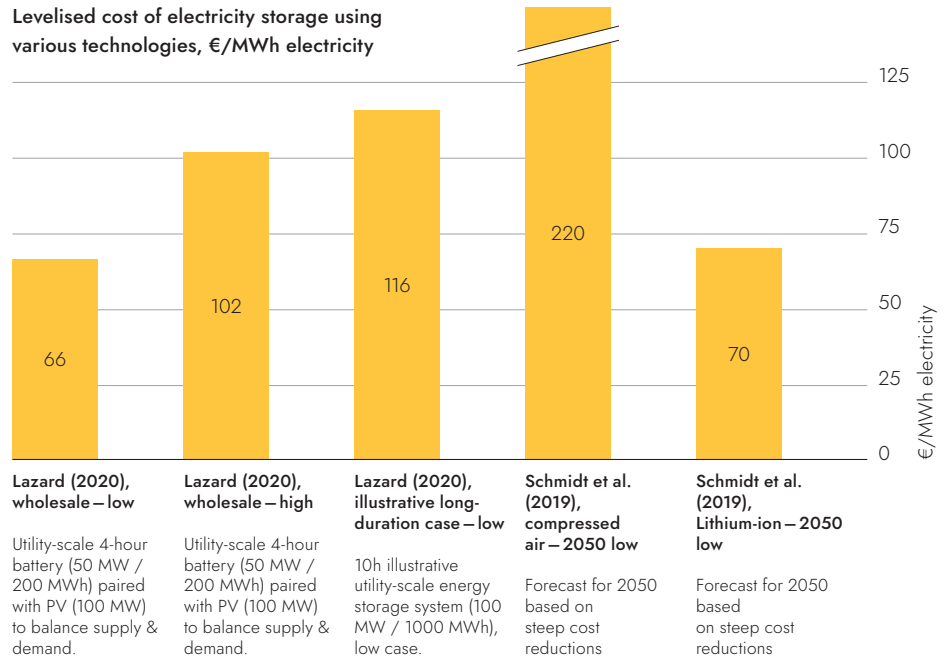
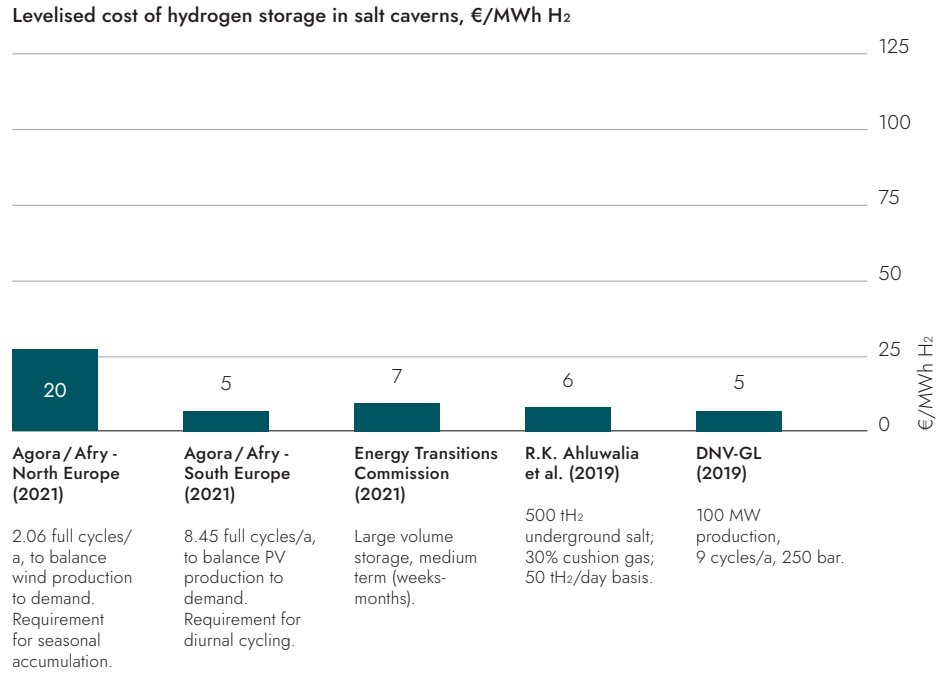

Sources: Agora: No regret Hydrogen (2021); Energy Transitions Commission: Making the Hydrogen Economy Possible (2021); R.K. Ahluwalia (2019); DNV-GL: Hydrogen in the Electricity Value Chain (2019); Lazard LCOS Analysis (2020); Schmidt et al. (2019).

The consideration between gas and electricity transport is not only an economic question but also one of societal acceptance. Although any type of infrastructure development can face public acceptance concerns, the energy transport alternatives compared in Figure 40 are of different scales. Whereas a 48-inch pipeline can have a throughput capacity of up to 16.9 GW and a 36-inch pipeline up to 4.7 GW, power lines considered in the analysis above – deemed realisable in Europe – have throughput capacities of 2 GW (per underground HVDC) to 3 GW (per overhead HVAC). This means that, to transport volumes of energy corresponding to a 48-inch pipeline—as is done today with natural gas—using power lines would require the equivalent of 5-6 overhead HVAC or 9 HVDC overhead transmission lines. Such a build-out, whether economically attractive or

not, will almost certainly run into a range of social acceptance issues, including land use and landscape pollution. In these cases, underground HVDC power lines may need to be considered, which are significantly more expensive.

Framing the discussion around energy transport infrastructure as a zero-sum game between hydrogen and electricity is suboptimal because it ignores complementary strengths and synergies that make both important for the affordability and security of Europe's future energy supply. Instead, the optimal infrastructure investment decisions depend on a range of factors including the local cost and availability of electricity and hydrogen supply, end uses, required energy profiles, interconnection costs, regional underground storage availability, terrain, and public acceptance.

When it comes to the topic of Europe's broader energy system, an integrated electricity and hydrogen grid will be more resilient and efficient than an electricity grid alone – for delivering electricity and hydrogen as end-uses alike. As identified in the European Commission's Energy System Integration Strategy, electricity and hydrogen infrastructure will work in harmony to create an integrated energy system, wherein consumers and investors are able to choose the option that best matches their need, based on prices that reflect the true cost and efficiency.

Appendix A.

Hydrogen Demand – Methodology

A.1. Industry

The industry chapter is based on bottom-up analysis on sector specific future hydrogen demand in fuels, HVC, ammonia and iron & steel. The hydrogen demand for industrial process heat is based on top-down analysis.

TABLE 5

Overview of expected industrial hydrogen demand per country (in TWh/year)

Country	2030					2040					2050				
	Ammonia	Fuels & HVC	Steel	Industrial heat	Total 2030	Ammonia	Fuels & HVC	Steel	Industrial heat	Total 2040	Ammonia	Fuels & HVC	Steel	Industrial heat	Total 2050
Austria	0.23	2.39	3.30	1.59	7.51	1.20	6.74	11.78	4.67	24.39	1.50	9.39	11.96	6.16	29.01
Belgium	0.95	9.58	4.29	3.04	17.86	5.06	27.05	9.10	8.73	49.94	6.33	37.71	7.90	11.37	63.31
Bulgaria	0.00	2.39	0.00	0.69	3.07	0.75	6.74	0.00	1.95	9.44	5.03	9.39	0.00	2.52	16.94
Croatia	0.00	1.64	0.00	0.25	1.89	0.35	4.63	0.00	0.71	5.69	2.33	6.45	0.00	0.93	9.71
Cyprus	0.00	0.00	0.00	0.00	0.00	0.00	0.00	0.00	0.00	0.00	0.00	0.00	0.00	0.00	0.00
Czech Republic	0.00	2.14	0.22	1.07	3.44	0.35	6.05	2.22	3.15	11.78	2.37	8.43	3.79	4.16	18.75
Denmark	0.00	2.20	0.00	0.38	2.58	0.00	6.22	0.00	1.13	7.35	0.00	8.67	0.00	1.51	10.18
Estonia	0.00	0.00	0.00	0.03	0.03	0.00	0.00	0.00	0.11	0.11	0.00	0.00	0.00	0.16	0.16
Finland	0.00	3.06	2.03	0.14	5.22	0.00	8.64	4.05	0.52	13.20	0.00	12.04	4.11	0.76	16.91
France	1.10	17.71	6.83	5.28	30.92	5.87	49.99	15.68	15.55	87.09	7.34	69.69	18.72	20.53	116.28
Germany	0.93	25.63	17.81	16.60	60.98	11.11	72.38	49.59	49.47	182.55	18.52	100.90	59.96	65.73	245.11
Greece	0.00	8.82	0.00	0.18	9.00	0.13	24.91	0.00	0.51	25.54	0.85	34.73	0.00	0.66	36.24
Hungary	0.00	2.02	0.15	0.76	2.93	0.58	5.70	1.53	2.17	9.98	3.85	7.95	2.61	2.83	17.23
Ireland	0.00	0.87	0.00	0.49	1.36	0.00	2.45	0.00	1.44	3.90	0.00	3.42	0.00	1.91	5.33
Italy	0.31	20.26	4.01	5.76	30.35	1.64	57.21	14.62	16.75	90.22	2.04	79.76	18.17	21.97	121.94
Latvia	0.00	0.00	0.00	0.04	0.04	0.00	0.00	0.00	0.12	0.12	0.00	0.00	0.00	0.15	0.15
Lithuania	0.00	2.32	0.00	0.21	2.53	0.89	6.56	0.00	0.58	8.03	5.91	9.15	0.00	0.74	15.81
Luxembourg	0.00	0.00	0.00	0.26	0.26	0.00	0.00	0.00	0.75	0.75	0.00	0.00	0.00	0.96	0.96
Malta	0.00	0.00	0.00	0.00	0.00	0.00	0.00	0.00	0.00	0.00	0.00	0.00	0.00	0.00	0.00
Netherlands	1.90	16.15	3.21	3.77	25.03	10.13	45.61	3.41	10.93	70.08	12.66	63.58	11.85	14.33	102.41
Poland	0.00	6.99	2.14	2.82	11.95	2.24	19.73	5.03	8.20	35.19	14.91	27.50	7.90	10.76	61.07
Portugal	0.00	5.26	0.00	0.85	6.11	0.00	14.86	0.00	2.46	17.31	0.00	20.71	0.00	3.22	23.93
Romania	0.00	2.91	3.28	1.67	7.87	1.79	8.22	4.98	4.65	19.64	11.95	11.46	5.05	5.96	34.42
Slovakia	0.00	1.52	0.42	0.35	2.29	0.47	4.28	4.17	0.97	9.89	3.14	5.97	7.11	1.23	17.45
Slovenia	0.00	0.00	0.00	0.34	0.34	0.00	0.00	0.00	0.99	0.99	0.00	0.00	0.00	1.30	1.30
Spain	0.25	18.67	3.39	5.34	27.65	3.02	52.72	8.40	15.60	79.74	5.03	73.50	8.53	20.52	107.58
Sweden	0.00	5.10	2.70	0.06	7.86	0.00	14.41	6.07	0.17	20.64	0.00	20.08	6.16	0.22	26.47
UK	1.42	17.79	1.37	4.24	24.82	7.55	50.24	2.87	12.42	73.07	9.44	70.03	5.05	16.36	100.88
Total	7.07	175.43	55.17	56.20	293.87	53.13	495.34	143.50	164.68	856.65	113.19	690.53	178.86	216.97	1,199.56

TABLE 6

Sources and assumptions for heavy road transport

Data category	Sources and assumptions										
Capacities and production per plant	<ul style="list-style-type: none"> Capacities based on EUROFER data²⁰¹ Utilization factor of 80% based on historic levels of past ten years Increase in capacity over time homogenously per plant, 106% by 2030, 113% by 2040 and 114% by 2050 (wrt current 2019 levels) based on Material Economics²⁰² 										
Decarbonisation pathways	<ul style="list-style-type: none"> Increase of secondary steel production to 50/50 share secondary/primary steel share, based on EUROFER estimates Full switch to DRI-EAF steelmaking by 2050, speed of adoption and intermediate pathways (hydrogen injection, natural gas instead of hydrogen in DRI and/or CCUS) are all based company announcements, company websites, GH expertise and interviews with steel companies 										
Hydrogen demand per decarbonisation technology	<ul style="list-style-type: none"> Hydrogen demand per technology stated in the table below verified by steelmakers <table border="1"> <thead> <tr> <th>Technology</th> <th>Hydrogen demand (MWh per ton of CS)</th> </tr> </thead> <tbody> <tr> <td>BF/BOF/CCU</td> <td>4.50</td> </tr> <tr> <td>H₂/DRI/EAF</td> <td>1.88</td> </tr> <tr> <td>BF/BOF/CCU/ H₂ injection</td> <td>5.05</td> </tr> <tr> <td>BF H₂ injection</td> <td>1.10</td> </tr> </tbody> </table>	Technology	Hydrogen demand (MWh per ton of CS)	BF/BOF/CCU	4.50	H ₂ /DRI/EAF	1.88	BF/BOF/CCU/ H ₂ injection	5.05	BF H ₂ injection	1.10
Technology	Hydrogen demand (MWh per ton of CS)										
BF/BOF/CCU	4.50										
H ₂ /DRI/EAF	1.88										
BF/BOF/CCU/ H ₂ injection	5.05										
BF H ₂ injection	1.10										

Data category	Sources and assumptions
Capacities and production per plant	<ul style="list-style-type: none"> Capacities based on a combination of FCH Observatory²⁰³ and press releases for individual installations Production capacity assumed constant over time
Decarbonisation pathways	<ul style="list-style-type: none"> Green hydrogen from electrolysis of water, blue hydrogen from SMR + CCS using fossil methane, and SMR using biomethane Countries categorized according to early or late adoption and likeliness of adoption of blue hydrogen Split of production by each pathway determined by GH expertise Full decarbonisation by 2050
Hydrogen demand per decarbonisation technology	<ul style="list-style-type: none"> Mole balance of Haber-Bosch process. 3 mol H₂/mol NH₃ = 5.9 MWh H₂/t NH₃ (LHV)

TABLE 7

Sources and assumptions for HVCs

Data category	Sources and assumptions
Capacities and production per plant	<ul style="list-style-type: none"> Ethylene production capacities based on international survey for steam crackers. New large Ineos Antwerp cracker has been added manually²⁰⁴. Using table 2-2 from Ren²⁰⁵ total HVC capacity is calculated from the ethylene capacity and feedstock shares, all per plant. Utilization factor of 100% based on GH expertise Stable capacity over time homogenously per plant: increase in demand is covered by increase in mechanical recycling, based on Material Economics²⁰⁶ new processes scenario
Decarbonisation pathways	<ul style="list-style-type: none"> Three decarbonisation pathways: <ul style="list-style-type: none"> Electric cracking Steam cracking with decarbonized energy carrier Methanol-to-Olefins (MtO) and three for decarbonisation of feedstock (assumed to be Naphtha for cracking or methanol for MtO): <ul style="list-style-type: none"> Bio-based Synthetic Chemical recycling Homogenous approach since no installation specific information is available with an end-state of three way split for both process and feedstock decarbonisation pathways. The future decarbonisation pathways are uncertain and among others dependent on resource availability (biomass, waste, hydrogen, renewable energy, biogenic or DAC CO₂). In reality, different plants will follow different pathways using different feedstocks and resources.
Hydrogen demand per decarbonisation technology	<ul style="list-style-type: none"> See Table 1 in HVC section for values, mostly based on Material Economics²⁰⁶ The feedstocks are assumed to be produced at fuel production locations, just as the fossil naphtha today is also produced at refineries. Hydrogen demand is thus included as fuel production in estimates.

TABLE 8

Sources and assumptions for fuel production

Data category	Sources and assumptions
Capacities and production per plant	<ul style="list-style-type: none"> Refining capacities are based CIEP data²⁰⁷. The future capacities is based on plant capacity relative to total refining capacity in EU+UK, thus the current market share remains the same per refinery.
Hydrogen demand per decarbonisation technology	<ul style="list-style-type: none"> Hydrogen demand for refining fossil fuels is taken from Agora/Afry²⁰⁸ Hydrogen demand for producing the feedstocks (methanol/naphtha) for HVCs is taken from HVC section Hydrogen demand for upgrading bio kerosene is taken from Ricardo²⁰⁹ at 0.15 MWh per MWh of biojet fuel (average of 3 technologies), bio kerosene fuel demand comes from transport section. Hydrogen demand for synthetic kerosene is assumed to be 430 kgs per ton of synthetic kerosene, the stoichiometric value. This could be more due to upgrading in reality, while also byproducts would be produced such as synthetic naphtha. Exactly calculating this would require an extensive separate study, where all transport sectors are included. Synthetic kerosene demand is calculated in the transport section. Total hydrogen demand is split up per refinery based on current capacity/market share of the refinery.

TABLE 9

Sources and assumptions for industrial process heat

Data category	Sources and assumptions
Natural gas demand (baseline)	<ul style="list-style-type: none"> FFE Extremos, 2021²¹⁰: Natural gas demand 2020 per NUTS 2 region for low-, medium-, and high-temperature industrial process heat (excluding spatial heating) Constant gas demand assumed
Hydrogen demand per temperature level	<ul style="list-style-type: none"> Low-temperature heat (<100°C): Full electrification assumed based on GH insights and FFE Extremos, 2021 Medium-temperature heat (100-500°C): 5% of current natural gas demand is replaced by hydrogen in 2030, 20% by 2040 and 30% by 2050 High temperature heat (>500°C): 15% of current natural gas demand is replaced by hydrogen in 2030, 40% by 2040 and 50% by 2050 For the conversion of natural gas demand in TWh to hydrogen demand in TWh for industrial heat, a study from DNV GL (2018)²¹¹ is used which assessed hydrogen use in industrial heating processes in the Netherlands. The energy demand when using hydrogen instead of natural gas is slightly lower at 88% of energy natural gas uses for low temperature heat and 85% for medium-and high temperature heat.

201 <https://www.eurofer.eu/about-steel/learn-about-steel/where-is-steel-made-in-europe/>202 <https://materialeconomics.com/publications/industrial-transformation-2050>203 <https://www.fchobservatory.eu/observatory/technology-and-market/hydrogen-demand>204 http://www.mrcplast.com/news-news_open-382294.html205 <https://dspace.library.uu.nl/bitstream/handle/1874/21674/NWS-E-2006-3.pdf?sequence=1>206 <https://materialeconomics.com/publications/industrial-transformation-2050>207 https://www.clingendaenergy.com/inc/upload/files/CIEP_paper_2017-02_web.pdf208 <https://www.agora-energiewende.de/en/press/news-archive/no-regret-hydrogen-infrastructure-for-europe/>209 [https://cdn.ricardo.com/ee/media/assets/hydrogen-demand-for-upgrading-biofuels-final-report_v2-\(002\).pdf](https://cdn.ricardo.com/ee/media/assets/hydrogen-demand-for-upgrading-biofuels-final-report_v2-(002).pdf)210 <http://opendata.ffe.de/dataset/final-energy-consumption-of-the-industry-sector-extremos-solideu-scenario-europe-nuts-0/>211 <https://www.dnv.com/oilgas/download/report-replace-natural-gas-with-hydrogen-for-industrial-heating-processes.html>

212 An analytical analysis is performed for aviation and heavy road transport determining the hydrogen demand in each sector. Although hydrogen can play a role, the decarbonisation pathways and hydrogen demand values for rail transport, passenger cars and light duty vehicles, and shipping are not performed due to their significantly lower hydrogen demand potentials and in the case of shipping, the uncertainty in the decarbonisation pathway.

A.2. Transport

The transport analysis is a bottom-up analysis that determines the total EU+UK energy demand pathway for heavy road transport and aviation.²¹² The total energy consumption for heavy road vehicles and aviation is based on the forecasted annual distance travelled, the energy consumption per technology, and the technology share. The transport pathways are disaggregated to country level energy demands based on historical data. The tables below give detailed information regarding the sources, assumptions, and values used in the analysis.

TABLE 10

Sources and assumptions for heavy road transport

Data category	Sources and assumptions
Annual distance travelled	<ul style="list-style-type: none"> – IEA MoMo model²¹³: Yearly annual distance travelled for Medium Freight, Heavy Freight, and Buses for 2020-2050 in 5-year increments
Energy consumption	<ul style="list-style-type: none"> – IEA MoMo model²¹³ for diesel trucks – 2% energy consumption improvements every 5 years²¹³ – Hydrogen fuel cell vehicles are assumed to have a 40% reduction in energy consumption relative to diesel trucks – Battery electric vehicles are assumed to use 65% less energy compared to diesel trucks – Natural gas trucks are assumed to use 10% more energy compared to a diesel truck
Technology share	<ul style="list-style-type: none"> – Updated from the Gas for Climate 2020 Pathways study²¹⁴ – Based on company announcements and literature – Technology share penetrations are modelled using S-curve technology adoption curves
Total historical energy demand	<ul style="list-style-type: none"> – Historical total road transport energy demand values from the European Environmental Agency²¹⁵ are used to verify the calculations
Country level disaggregation	<ul style="list-style-type: none"> – Based on IEA MoMo model²¹⁶ annual distance travelled, given per region – The region data is disaggregated using Freight distance per country data in the European Commission Statistical Pocketbook²¹⁷

TABLE 11

Annual distance travelled per transport type for 2020-2050 in billion km/year for EU+UK

Transport type	Transport subtype	2020	2025	2030	2035	2040	2045	2050
Freight vehicles	Medium freight	96	82	78	77	74	69	66
Freight vehicles	Heavy freight	225	222	219	216	214	211	208
Buses	Buses	22	25	28	32	35	38	42
Buses	Coaches	11	11	11	12	12	13	13

213 IEA (2021). The IEA Mobility Model. <https://www.iea.org/areas-of-work/programmes-and-partnerships/the-iea-mobility-model>

214 Gas for Climate (2020). Gas decarbonisation pathways study. https://gasforclimate2050.eu/sdm_downloads/2020-gas-decarbonisation-pathways-study/

215 European Environment Agency (2021). Final energy consumption in Europe by mode of transport. <https://www.eea.europa.eu/data-and-maps/indicators/transport-final-energy-consumption-by-mode/assessment-10>

216 IEA (2021). The IEA Mobility Model. <https://www.iea.org/areas-of-work/programmes-and-partnerships/the-iea-mobility-model>

217 European Commission (2017). Statistical pocketbook. https://ec.europa.eu/transport/facts-fundings/statistics/pocketbook-2017_en

TABLE 12

Technology share per road transport type for 2020-2050

Transport type	Technology	2020	2025	2030	2035	2040	2045	2050
Freight vehicles	Electricity	0%	1%	6%	11%	21%	30%	35%
	Hydrogen	0%	0%	5%	13%	30%	47%	55%
	(bio)-LNG/CNG	2%	12%	30%	40%	32%	18%	10%
	Diesel	97%	87%	60%	35%	18%	6%	0%
Buses	Electricity	1%	3%	12%	38%	64%	73%	75%
	Hydrogen	0%	1%	4%	13%	21%	24%	25%
	(bio)-LNG/CNG	3%	3%	3%	2%	0%	0%	0%
	Diesel	96%	93%	82%	48%	14%	3%	0%

TABLE 13

Sources and assumptions for aviation

Data category	Sources and assumptions
Annual distance travelled	– IEA MoMo model ²¹² : Yearly annual distance travelled for Passenger Aviation and Freight Aviation for 2020-2050 in 5-year increments
Energy consumption	– 34 passenger-km/L for average aircraft ²¹⁸ – 1.5% energy consumption improvement per year ²¹⁹ – Hydrogen fuel cell aircrafts are assumed to have an 8% reduction in energy consumption relative to aircrafts powered by jet fuel (Based on regional aircraft in FCH's Hydrogen powered aviation report) ²²⁰ – Battery electric vehicles are assumed to use the same energy consumption as aircrafts powered by jet fuel due to the relatively low energy density but higher efficiency of batteries (Based on efficiency and energy density of batteries and jet fuel ²²¹)
Technology share	– Updated from the Gas for Climate 2020 Pathways study ²²² – Based on company announcements and literature – Technology share penetrations are modelled using S-curve technology adoption curves
Country level disaggregation	– Freight air travel is disaggregated freight tonnage per country data from the World Bank ²²³ – Passenger air travel is disaggregated base on air passengers carried per country data from the World Bank ²²⁴
Total historical energy demand	– Historical total road transport energy demand values from the European Environmental Agency ²²⁵ are used to verify the calculations

218 ICCT (2018). Transatlantic Airline Fuel Efficiency Ranking, 2017. https://theicct.org/sites/default/files/publications/Transatlantic_Fuel_Efficiency_Ranking_20180912.pdf

219 IATA (2021). Fuel Efficiency. <https://www.iata.org/en/programs/ops-infra/fuel/fuel-efficiency/>

220 FCH (2020). Hydrogen-powered aviation. https://www.fch.europa.eu/sites/default/files/FCH%20Docs/20200507_Hydrogen%20Powered%20Aviation%20report_FINAL%20web%20%28ID%208706035%29.pdf

221 Hepperle, M. (2018). Electric Flight – Potential and Limitations. <https://nag.aero/wp-content/uploads/2018/05/MP-AVT-209-09-Electric-Flight-Potential-and-Limitations.pdf>

222 Gas for Climate (2020). Gas decarbonisation pathways study. https://gasforclimate2050.eu/sdm_downloads/2020-gas-decarbonisation-pathways-study/

223 World Bank (2020). Air transport, freight. <https://data.worldbank.org/indicator/IS.AIR.GOOD.MT.K1?view=chart>

224 World Bank (2020). Air transport, passengers carried. <https://data.worldbank.org/indicator/IS.AIR.PSGR?view=chart>

225 European Environment Agency (2021). Final energy consumption in Europe by mode of transport. <https://www.eea.europa.eu/data-and-maps/indicators/transport-final-energy-consumption-by-mode/assessment-10>

TABLE 14

Technology share per aviation technology for 2020-2050

Technology	2020	2025	2030	2035	2040	2045	2050
Electricity	0%	0%	0%	0%	1%	5%	10%
Hydrogen	0%	0%	0%	0%	1%	5%	10%
Synthetic Kerosene	0%	2%	7%	20%	33%	38%	40%
Bio Jet fuel	0%	2%	7%	20%	33%	38%	40%
Jet Fuel	100%	96%	85%	59%	32%	14%	0%

TABLE 15

Direct Hydrogen demand per country for the transport sector for 2020-2050. (TWh/year)

Country	2020	2025	2030	2035	2040	2045	2050
Austria	0.0	0.0	0.3	0.9	2.1	3.8	5.6
Belgium	0.0	0.0	0.3	1.0	2.1	3.3	4.2
Bulgaria	0.0	0.0	0.3	0.9	1.8	2.6	2.9
Croatia	0.0	0.0	0.1	0.3	0.7	1.0	1.3
Czech Republic	0.0	0.0	0.5	1.6	3.4	4.9	5.7
Cyprus	0.0	0.0	0.0	0.1	0.1	0.2	0.2
Denmark	0.0	0.0	0.3	1.0	2.3	3.7	4.7
Estonia	0.0	0.0	0.1	0.2	0.4	0.6	0.7
Finland	0.0	0.0	0.4	1.3	2.9	4.5	5.8
France	0.0	0.1	3.3	9.8	21.3	33.3	41.5
Germany	0.0	0.1	3.0	9.0	19.8	32.0	41.5
Greece	0.0	0.0	0.3	1.0	2.0	3.0	3.8
Hungary	0.0	0.0	0.4	1.3	2.7	4.5	6.1
Ireland	0.0	0.0	0.2	0.8	2.3	6.0	11.2
Italy	0.0	0.1	2.2	6.7	13.8	20.1	23.4
Latvia	0.0	0.0	0.1	0.3	0.7	1.2	1.5
Lithuania	0.0	0.0	0.2	0.6	1.3	1.9	2.2
Luxembourg	0.0	0.0	0.1	0.2	0.5	1.1	1.9
Malta	0.0	0.0	0.1	0.3	0.6	0.9	1.2
Netherlands	0.0	0.0	0.7	2.1	4.7	8.0	10.8
Poland	0.0	0.0	2.5	7.2	15.5	23.0	26.6
Portugal	0.0	0.0	0.3	0.9	2.0	3.2	4.1
Romania	0.0	0.0	0.4	1.1	2.3	3.4	4.2
Sweden	0.0	0.0	0.7	1.9	4.2	6.5	7.9
Slovenia	0.0	0.0	0.1	0.4	0.9	1.4	1.6
Slovakia	0.0	0.0	0.4	1.1	2.4	3.5	4.1
Spain	0.0	0.1	1.9	5.5	11.9	18.7	23.7
United Kingdom	0.0	0.1	2.4	7.2	16.3	27.3	36.7
EU+UK	0.0	0.7	21.4	64.8	141.1	223.6	285.1

A.3. Power

The analysis on hydrogen demand in the power system is based on ENTSO-E's TYNDP 2020 Scenario Report²²⁶ and the Gas for Climate 2020 'Gas Decarbonisation pathways study'²²⁷. The total EU electricity generation values are based on the Gas for Climate 2020 'Gas Decarbonisation pathways study'²²⁷, leading to 3674, 4166, and 4633 TWh of electricity generation in 2030, 2040, and 2050, respectively. The breakdown of generation per generation type and per country in the EU are based directly on ENTSO-E's TYNDP 2020 Scenario Report for 2030 and 2040²²⁶. The generation values are then scaled to result in the Gas for Climate total electricity generation values listed above. This leads to a total gas generation in the EU+UK of 496 TWh in 2030 and 436 TWh in 2040. To forecast the necessary gas generation values for 2050, the TYNDP2020 values are extrapolated. Nuclear power is extrapolated to 2050 using the 2030 and 2040 TYNDP forecasts, hydropower is assumed to remain constant from 2040 to 2050, total EU+UK generation is assumed to increase by 0.2% per year with country level generation following the trend from 2030 to 2040. Total solar and wind generation are expected to comprise of 15% and 50%, respectively of total generation. Country level solar and wind generation in 2050 are expected to grow considering the growth in 2030 to 2040 and the reduction in fossil and nuclear generation plants. Electricity from batteries in 2050 is extrapolated from 2030 and 2040 values. Gas generation in 2050 is extrapolated from 2030 and 2040 values considering the change in total per country generation and in solar, wind, hydro, nuclear, coal, lignite, and oil generation. The generation values are then scaled to the Gas for Climate 2020 'Gas Decarbonisation pathways study'²²⁷ total 2050 electricity generation of 4633 TWh, leading to a total gas generation of 440 TWh in 2050. Based on the Gas for Climate 2020 study²²⁷, the hydrogen demand for 2030, 2040, and 2050 is calculated assuming that 1%, 35%, and 70% of the gas generation is hydrogen respectively and that hydrogen-to-power has an efficiency of 50%²²⁸. This results in 12 TWh of hydrogen in 2030, 301 TWh in 2040, and 625 TWh in 2050. All sources, assumptions, and calculation methods are shown in the table below.

226 ENTSO-E (2020). TYNDP 2020 Scenario Report. <https://2020.entsos-tyndp-scenarios.eu/>

227 Gas for Climate (2020). Gas decarbonisation pathways study. https://gasforclimate2050.eu/sdm_downloads/2020-gas-decarbonisation-pathways-study/

228 In this study, gas to power is generalised to include power generated both in gas fired turbines and in hydrogen fuel cells. An efficiency of 50% is assumed for both applications.

TABLE 16

Hydrogen demand in power – sources, assumptions, methods

Data category	Sources, assumptions, and methods
Total generation	<ul style="list-style-type: none"> – 2030: 3674 TWh²²⁹ – 2040: 4166 TWh²²⁹ – 2050: 4633 TWh²²⁹
Per country generation	<ul style="list-style-type: none"> – 2030 & 2040: ENTSO-E's TYNDP²³⁰ – 2050: Extrapolated from 2030 and 2040 country level generation values and based on the 2050 total generation value
Nuclear generation	<ul style="list-style-type: none"> – 2030 & 2040: ENTSO-E's TYNDP²³⁰ – 2050: <ul style="list-style-type: none"> – Countries with increasing amounts of nuclear generated electricity from 2030 to 2040 are assumed to maintain 2040 generation values in 2050 – Countries with decreasing shares of nuclear power from 2030 to 2040 are linearly extrapolated to 2050
Hydro power	<ul style="list-style-type: none"> – 2030 & 2040: ENTSO-E's TYNDP²³⁰ – 2050: Assumed that hydro power remains constant at 2040 values
Coal, lignite, oil	<ul style="list-style-type: none"> – 2030 & 2040: ENTSO-E's TYNDP²³⁰ – 2050: Linearly extrapolated from 2030 and 2040 values
Solar generation	<ul style="list-style-type: none"> – 2030 & 2040: ENTSO-E's TYNDP²³⁰ per country values – 2050: total solar generation is assumed to be 15% of total generation – Country level solar generation values are extrapolated given the country level generation values and the change in nuclear, hydro power, coal, lignite, and oil generation
Wind power	<ul style="list-style-type: none"> – 2030 & 2040: ENTSO-E's TYNDP²³⁰ per country values – 2050: total wind generation is assumed to be 50% of total generation – Country level wind generation values are extrapolated given the country level generation values and the change in nuclear, hydro power, coal, lignite, and oil generation
Other renewables	<ul style="list-style-type: none"> – 2030 & 2040: ENTSO-E's TYNDP²³⁰ per country values – 2050: Assumed to remain constant at 2040 values
Battery	<ul style="list-style-type: none"> – 2030 & 2040: ENTSO-E's TYNDP²³⁰ per country values – 2050: Linearly extrapolated from 2030 & 2040 values
Gas generation	<ul style="list-style-type: none"> – 2030 & 2040: ENTSO-E's TYNDP²³⁰ per country values – 2050: Extrapolated from 2030 & 2040 values considering the change in total per country generation and in solar, wind, hydro, nuclear, coal, lignite, and oil generation
Hydrogen share of gas generation	<ul style="list-style-type: none"> – Hydrogen share of gas generation is assumed to be 1% in 2030, 35% in 2040, and 70% in 2050 based on GfC 2020 Pathways study²³¹
Gas-to-power efficiency	<ul style="list-style-type: none"> – 50% efficiency^{227,232}

229 Gas for Climate (2020). Gas decarbonisation pathways study. https://gasforclimate2050.eu/sdm_downloads/2020-gas-decarbonisation-pathways-study/

230 ENTSO-E (2020). TYNDP 2020 Scenario Report. <https://2020.entsoe-tyndp-scenarios.eu/>

231 Gas for Climate (2020). Gas decarbonisation pathways study. https://gasforclimate2050.eu/sdm_downloads/2020-gas-decarbonisation-pathways-study/

232 In this study, gas to power is generalised to include power generated both in gas fired turbines and in hydrogen fuel cells. An efficiency of 50% is assumed for both applications. In the short term, hydrogen can be blended with natural gas to power gas turbines.

TABLE 17

Power sector hydrogen demand per country
for 2030, 2040, and 2050 (TWh/year)

Country	2020	2040	2050
Austria	0	4	9
Belgium	1	13	27
Bulgaria	0	2	4
Croatia	0	0	1
Czech Republic	0	0	1
Cyprus	0	0	1
Denmark	0	3	7
Estonia	0	1	1
Finland	0	1	4
France	0	9	24
Germany	3	78	183
Greece	0	1	4
Hungary	0	1	2
Ireland	0	7	14
Italy	2	50	92
Latvia	0	0	0
Lithuania	0	2	3
Luxembourg	0	0	0
Malta	0	0	1
Netherlands	1	13	20
Poland	1	37	66
Portugal	0	3	5
Romania	0	2	8
Sweden	0	0	0
Slovenia	0	2	4
Slovakia	0	1	2
Spain	1	15	34
United Kingdom	2	56	106
Total	12	301	625

A.4. Buildings

TABLE 18

Floor space estimates per country (2020)

Country	Residential floor area	Service floor area	Useful energy demand
	million m ²	million m ²	kWh/m ²
Austria	117	459	141.52
Belgium	144	537	167.55
Bulgaria	71	297	53.92
Croatia	35	175	47.66
Czech Republic	105	405	153.41
Cyprus	7	48	48.30
Denmark	121	421	136.50
Estonia	48	98	148.20
Finland	101	303	203.67
France	873	3493	114.65
Germany	1662	5227	164.02
Greece	125	561	107.85
Hungary	104	416	142.22
Ireland	57	222	125.79
Italy	399	3047	101.37
Latvia	18	81	192.26
Lithuania	35	118	139.09
Luxembourg	7	31	200.39
Malta	4	19	26.21
Netherlands	303	955	141.76
Poland	404	1340	115.20
Portugal	100	617	70.82
Romania	78	539	112.57
Slovakia	50	188	105.85
Slovenia	24	93	140.52
Spain	362	2235	58.82
Sweden	167	581	137.54
United Kingdom	728	2907	127.34

Source: Hotmaps

TABLE 19

Estimate of fuel share mix per country (2020)

Country	District heat	Biomass	Natural gas	Other renewables (e.g. solar thermal)	Electricity	Oil
Austria	23.3%	19.5%	26.2%	4.4%	7.8%	18.8%
Belgium	1.0%	5.3%	51.1%	9.0%	5.2%	28.4%
Bulgaria	19.6%	32.7%	6.2%	5.6%	18.3%	17.6%
Croatia	12.9%	22.3%	37.6%	4.2%	10.9%	12.2%
Cyprus	0.0%	1.3%	0.0%	27.4%	13.5%	57.7%
Czech Republic	20.6%	14.4%	46.3%	1.5%	6.8%	10.4%
Denmark	49.9%	15.8%	18.0%	3.8%	4.6%	7.8%
Estonia	43.9%	28.7%	7.6%	6.1%	11.2%	2.5%
Finland	43.1%	15.4%	0.6%	8.3%	21.8%	10.8%
France	4.7%	14.6%	42.9%	8.2%	12.2%	17.4%
Germany	9.6%	8.2%	46.4%	12.0%	3.0%	20.8%
Greece	0.7%	10.7%	8.4%	8.4%	7.1%	64.7%
Hungary	12.7%	11.5%	64.6%	0.3%	5.2%	5.6%
Ireland	0.0%	1.4%	31.9%	12.9%	7.7%	46.0%
Italy	2.2%	14.6%	57.3%	5.7%	9.6%	10.7%
Latvia	31.9%	42.1%	14.3%	4.3%	2.5%	4.8%
Lithuania	35.2%	45.4%	10.2%	2.5%	2.5%	4.3%
Luxembourg	8.7%	2.7%	49.9%	9.1%	2.2%	27.4%
Malta	0.0%	1.0%	0.0%	6.9%	49.6%	42.4%
Netherlands	4.3%	2.4%	86.9%	1.8%	2.6%	2.0%
Poland	27.9%	10.4%	20.7%	5.5%	3.7%	31.8%
Portugal	1.2%	21.3%	22.4%	7.6%	8.5%	38.9%
Romania	19.2%	46.0%	30.6%	0.8%	1.7%	1.8%
Slovakia	38.5%	1.4%	51.9%	2.4%	1.7%	3.9%
Slovenia	10.1%	40.6%	11.0%	9.6%	7.8%	21.0%
Spain	0.4%	14.5%	31.7%	10.2%	7.6%	35.5%
Sweden	49.3%	12.1%	1.9%	16.0%	14.8%	5.9%
United Kindom	1.2%	1.1%	80.2%	2.2%	6.5%	8.8%

Source: Hotmaps

TABLE 20

Final energy savings per country, relative to untouched

Country	Energy related renovations “Light”	Energy related renovations “Medium”	Energy related renovations “Deep”
Austria	10.9%	42.9%	64.2%
Belgium	12.7%	40.3%	66.9%
Bulgaria	15.2%	42.7%	61.0%
Croatia	15.2%	41.9%	64.5%
Cyprus	12.5%	49.6%	64.1%
Czech_Republic	14.4%	41.0%	66.1%
Denmark	12.0%	42.8%	65.0%
Estonia	13.7%	41.7%	65.1%
Finland	10.3%	45.8%	62.7%
France	12.0%	42.9%	66.1%
Germany	12.6%	42.8%	64.9%
Greece	11.3%	45.6%	69.9%
Hungary	11.9%	41.6%	64.4%
Ireland	12.3%	43.2%	64.7%
Italy	13.3%	41.6%	68.2%
Latvia	11.4%	41.5%	63.7%
Lithuania	11.6%	37.9%	61.2%
Luxembourg	13.1%	46.2%	66.5%
Malta	12.3%	44.8%	68.9%
Netherlands	12.2%	39.1%	67.1%
Poland	11.5%	37.5%	69.6%
Portugal	13.5%	42.8%	65.7%
Romania	14.4%	42.6%	62.3%
Slovakia	13.7%	41.6%	62.9%
Slovenia	14.9%	40.7%	63.7%
Spain	17.1%	42.6%	67.8%
Sweden	10.1%	45.3%	62.8%
United_Kingdom	13.6%	44.4%	66.2%

Source: Guidehouse

Appendix B.

Hydrogen Supply – Methodology

B.1. Green Hydrogen

Technical potential

The technical renewable energy potential considers the theoretical energy potential based on wind speeds and solar irradiation data (capacity factors), bearing in mind technical restrictions. The main technical restriction is the physical suitability of sites. For example, wind turbines and ground-mount PV parks cannot be installed in urban areas. Table 21 summarises the sources, assumptions, and constraints considered when estimating the technical potential.

TABLE 21

Technical potential – sources, assumptions, and constraints

Technology	Sources, assumptions, and constraints
Solar PV	<p>The starting point is the ENSPRESO “170 W/m², 100%” land scenario, which assumes that:</p> <ul style="list-style-type: none"> – Urban, industry, forests, transitional woodland-shrub, new energy crops, natural land, infrastructure, wetlands, water bodies, urban green leisure, and other natural land areas are excluded for ground-mount – All land areas except for urban and industrial areas are excluded for rooftop <p>In this study the performance ratio is increased to 100% (actual electricity produced as a share of the PV panel’s rated capacity), rather than the 75% assumed in the original ENSPRESO database.</p>
Wind: onshore	<p>Technical potential for onshore wind assumes the same values as the ENSPRESO “EU-wide low-restrictions” scenario ENSPRESO “EU-wide low-restrictions” scenario, which assumes that:</p> <ul style="list-style-type: none"> – Urban, industry, forests, transitional woodland-shrub, infrastructure, wetlands, water bodies, urban green leisure, and other natural land areas are excluded – Distance from settlements is 120 m for small turbines and 400 m for big turbines in all countries
Wind: offshore	<p>Technical potential for offshore wind assumes the same values as the ENSPRESO “EU-wide low restrictions” scenario ENSPRESO “EU-wide low restrictions” scenario, which assumes that:</p> <ul style="list-style-type: none"> – There is no constraint with regards to distances to shore & inland waters – Distance to ship lanes, pipelines, gas wells, and submarine cables has to be greater than 2 nm – Only areas with sea depths less than 1000 m and shipping densities less than 5000 ships per year are considered

Realistic potential

Even when there might be enough space or resource available for renewable energy production from a technical perspective, it is often not desirable to utilise all this technical potential. The realistic renewable energy potential takes into account these constraints by considering planning issues, competition for land-use, environmental regulations, and public acceptance. Table 22 below summarises the sources, assumptions, and constraints when estimating the realistic potential.

TABLE 22

Realistic potential – sources, assumptions, and constraints

Technology	Sources, assumptions, and constraints
Solar PV	<p>For each country, 0.1-2.0% of non-artificial areas are available for ground-mount solar PV depending on population density of the country in consideration, according to the following criteria:</p> <ul style="list-style-type: none"> – 0-50 persons/km²: 2.0% – 50-100 persons/km²: 1.5% – 100-150 persons/km²: 0.75% – 150-200 persons/km²: 0.50% – 200-250 persons/km²: 0.25% – > 250 persons/km²: 0.10%
Wind: onshore	<ul style="list-style-type: none"> – ENSPRESO “EU-wide high restrictions” scenario – a hypothetical scenario in which the exclusion of surfaces for wind converges in all countries to a high level – Capacity factors > 25% – Distance from settlements: 1200 m for small turbines, 2000 m for big turbines
Wind: offshore	<ul style="list-style-type: none"> – Wind Europe – “Our energy, our future” scenario in line with the European Commission’s 300 GW of offshore wind target by 2050 – Includes floating technology

Renewable energy potential – installation rates

In this step the deployment of technologies at a certain point in time is taken into account. The realisable renewable energy potential considers limitations related to lead times and maximum deployment growth rates, building up to 80% of the realistic potential over time. Whereas the realistic renewable energy potential is time-independent, the realisable potential increases over time.

To determine the share of the realistic potential which is realisable by 2030, 2040, and 2050 – we look at shares of renewable sources in gross electricity consumption per country, as reported by the European Commission for the year 2019.²³³ Countries with a higher share of renewables today are assigned a faster realisable deployment rate, although this rate converges to 80% of the realistic potential across all European countries by 2050. This approach is shown in Table 23.

TABLE 23

Realisable deployment rates as a function of present renewables penetration

Share of renewables in gross electricity consumption (2019)	2030	2040	2050
< 33%	25%	53%	80%
33% < x < 67%	35%	58%	80%
> 67%	45%	63%	80%

233 Eurostat (2020). Share of energy from RES in gross electricity consumption in 2019. <https://ec.europa.eu/eurostat/web/energy/data/shares>.

Final electricity demand, power-to-hydrogen-to-power, and net potential available for dedicated green hydrogen production

Given the many decarbonisation benefits of combining rapid deployment of renewables with widespread electrification of end-use technologies, we assume final electricity demand – net of firm generation – receives priority access to renewable energy supply. Hence, a thorough assessment of final electricity demand is essential to understand the net realisable renewable energy potential which in fact remains available for green hydrogen production.

We make use of final electricity demand figures presented in Chapter 1 of this study and use extrapolated production figures from TYNDP’s Global Ambition Scenario to estimate country-specific quantities of non-hydrogen forms of dispatchable electricity production in 2030, 2040, and 2050.

Green hydrogen conversion considerations

Conversion losses associated with hydrogen production from water electrolysis must also be considered. We assume that electrolysis conversion efficiencies improve gradually over time, starting at 71% in 2030 and reaching 76% and 80% by 2040 and 2050, respectively.

Country-level figures

TABLE 24

Realistic renewable energy potential per country (GW)

Country	PV	PV: rooftop	Wind onshore	Wind offshore
Austria	31	20	17	0
Belgium	2	27	0	6
Bulgaria	164	18	3	0
Croatia	51	10	3	0
Czechia	46	25	6	0
Cyprus	17	2	0	0
Denmark	31	14	13	35
Estonia	29	3	17	7
Finland	32	14	80	17
France	122	153	164	58
Germany	60	191	22	36
Greece	198	24	89	10
Hungary	82	24	10	0
Ireland	46	11	71	22
Italy	77	136	48	10
Latvia	52	5	38	3
Lithuania	103	7	50	4
Luxembourg	0	0.857	0.5	0
Malta	0	1	0	10
Netherlands	3	39	4	60
Poland	183	91	90	28
Portugal	42	23	3	9

Country	PV	PV: rooftop	Wind onshore	Wind offshore
Romania	396	48	17	0
Sweden	64	24	100	20
Slovenia	8	5	0	0
Slovakia	27	13	5	0
Spain	776	99	244	13
United Kingdom	15	148	154	80

TABLE 25

Realisable renewable energy potential per country (GW)

Country	2030				2040				2050			
	PV: ground	PV: rooftop	Wind onshore	Wind offshore	PV: ground	PV: rooftop	Wind onshore	Wind offshore	PV: ground	PV: rooftop	Wind onshore	Wind offshore
Austria	14	9	8	0	19	13	11	0	25	16	14	0
Belgium	10	7	4	3	10	14	4	4	10	22	4	5
Bulgaria	41	5	1	0	86	10	2	0	131	15	3	0
Croatia	18	4	1	0	30	6	2	0	41	8	3	0
Czechia	11	6	1	0	24	13	3	0	37	20	4	0
Cyprus	4	1	0	0	9	1	0	0	14	2	0	0
Denmark	11	6	10	8	18	8	10	21	25	11	10	28
Estonia	7	1	4	1	15	2	9	4	23	3	14	6
Finland	11	6	28	3	18	8	46	10	26	11	64	13
France	44	38	41	9	64	80	86	35	97	122	132	46
Germany	98	69	20	15	98	110	20	21	98	153	20	28
Greece	50	7	22	2	104	13	47	6	159	19	71	8
Hungary	20	6	2	0	43	13	5	0	65	19	8	0
Ireland	16	8	25	4	27	8	41	13	37	9	57	18
Italy	51	48	17	2	51	78	28	6	61	109	38	8
Latvia	18	2	13	0	30	3	22	2	42	4	31	2
Lithuania	26	2	12	1	54	4	26	2	82	6	40	3
Luxembourg	0	0.608	0.4	0	0	0.857	0.5	0	0	0.857	0.5	0
Malta	0	0	0	2	0	0	0	6	0	1	0	8
Netherlands	27	10	12	10	27	20	12	36	27	31	12	48
Poland	46	23	23	5	96	48	47	17	147	73	72	22
Portugal	15	9	1	1	24	13	2	5	33	18	2	7
Romania	139	17	6	0	228	28	10	0	317	38	13	0
Sweden	29	12	17	3	40	15	30	12	51	19	40	16
Slovenia	2	1	0	0	4	3	0	0	7	4	0	0
Slovakia	7	3	1	0	14	7	3	0	21	11	4	0
Spain	272	47	85	2	446	57	140	8	621	79	195	10
United Kingdom	5	52	54	30	9	85	88	48	12	118	123	64

TABLE 26

Renewable energy potential per country
(TWh/year)

Country	2030	2040	2050
Austria	50	70	89
Belgium	22	36	50
Bulgaria	73	153	234
Croatia	36	60	83
Czechia	25	53	81
Cyprus	10	21	32
Denmark	68	150	204
Estonia	25	59	87
Finland	110	204	281
France	244	576	850
Germany	192	302	415
Greece	171	369	559
Hungary	44	93	142
Ireland	137	260	358
Italy	168	286	396
Latvia	59	102	141
Lithuania	66	143	217
Luxembourg	2	2	2
Malta	5	17	23
Netherlands	58	189	257
Poland	161	364	541
Portugal	39	74	101
Romania	245	402	559
Sweden	108	201	265
Slovenia	5	10	15
Slovakia	16	34	51
Spain	740	1,232	1,713
United Kingdom	384	628	860

TABLE 27

Final electricity demand (TWh/year)

Country	2030	2040	2050
Austria	105	128	154
Belgium	107	115	121
Bulgaria	36	38	40
Croatia	21	24	25
Czechia	80	90	99
Cyprus	7	8	9
Denmark	54	70	90
Estonia	11	13	16
Finland	111	123	135
France	489	549	607
Germany	668	708	742
Greece	73	79	83
Hungary	54	60	66



Country	2030	2040	2050
Ireland	48	53	59
Italy	376	423	471
Latvia	11	15	20
Lithuania	14	18	23
Luxembourg	6.5	6.8	6.8
Malta	3	4	6
Netherlands	134	143	151
Poland	199	239	283
Portugal	47	50	52
Romania	72	81	90
Sweden	165	187	210
Slovenia	15	18	19
Slovakia	34	36	39
Spain	311	376	350
United Kingdom	415	484	557

TABLE 28

Hydro, nuclear, fossil, and other non-PV and wind electricity generation (TWh/year)

Country	2030	2040	2050
Austria	25	18	15
Belgium	15	12	10
Bulgaria	22	14	11
Croatia	5	4	3
Czechia	28	19	16
Cyprus	2	1	0
Denmark	7	5	4
Estonia	2	1	1
Finland	40	19	15
France	245	109	88
Germany	126	66	54
Greece	15	7	6
Hungary	15	6	5
Ireland	8	4	3
Italy	93	62	50
Latvia	2	1	1
Lithuania	2	2	1
Luxembourg	0.439	0.436	0.436
Malta	0	0	0
Netherlands	32	12	10
Poland	68	41	34
Portugal	11	8	6
Romania	27	16	13
Sweden	71	34	27
Slovenia	12	15	8
Slovakia	17	11	9
Spain	64	28	23
United Kingdom	88	68	55

TABLE 29

Overview of renewable energy targets announced in National Energy and Climate Plans (GW) in 2030

Country	PV	Wind: onshore	Wind: offshore
Austria	9.7	6.5	0
Belgium	10.27	4.9	4
Bulgaria	3.2	1	0
Croatia	0.8	1.4	0
Cyprus		0.2	0
Czechia	4	1	0
Denmark	7.8	6.3	10.3
Estonia	0.4	0.5	0.7
Finland	1	5.5	0.07
France	44	37.7	7.4
Germany	98	69	20
Greece	7.7	7.1	0
Hungary	6.4	0.33	0
Ireland	2.5	8.2	5
Italy	51.2	18.4	0.9
Latvia		1.1	0
Lithuania	0.13	0.9	0.7
Luxembourg	1	0.3	0
Malta		0	0
Netherlands	27	9	11.5
Poland	7.3	15	7
Portugal	9	9	0.2
Romania	5.1	5.3	0.3
Slovakia	1.2	0.5	0
Slovenia	1.65	0.15	0
Spain	39.2	47.3	3
Sweden	2	12	0.2
United Kingdom			40

Levelised cost of green hydrogen

TABLE 30

Electrolyser techno-economic assumptions used to calculate the levelised cost of green hydrogen production (based on Alkaline technology at large scale >100 MW)

	2030	2040	2050
Efficiency (LHV)	71% ²³⁴	76%	80%
CAPEX (€/kWe)	270.00	201.75	133.50
High	425.00	312.50	200.00
Medium	270.00	201.75	133.50
Low	115.00	91.00	67.00
Electrolyser stack replacement cost (after half of lifetime)	35.0% of capex		
Electrolyser opex (of yearly CAPEX)	5%		
Electrolyser lifetime (years)	30		
Electrolyser availability	95%		
Coincidence factor for hybrid (solar + wind) plants	15%		

Medium case is used in calculations. Sources: BNEF, Hydrogen Project Valuation (H2Val) Model; Agora & AFRY, No-regret hydrogen; Florence School of Regulation, Clean Hydrogen Costs in 2030 and 2050.

TABLE 31

Renewable energy capex assumptions used to calculate the levelised cost of green hydrogen production

€/kW	2030	2040	2050
PV	330	290	250
Wind onshore	800	743	686
Hybrid	1130	1033	936
Wind offshore	1179	995	811

TABLE 32

Renewable energy opex assumptions used to calculate the levelised cost of green hydrogen production

€/kW/year	2030	2040	2050
PV	8	7	6
Wind onshore	36	34.5	33
Hybrid	44	41.5	39
Wind offshore	95	87	79

²³⁴ High temperature electrolyzers/Solid Oxide Electrolyzers (SOEL) already reach efficiency levels of above 85% (LHV) and higher, but need steam as input. This steam could come from industrial source or e.g. from the Fischer-Tropsch process for e-fuel production. This technology is not considered in the centralised scenario this study assumes, but could play a substantial role in e.g. e-fuel production.

TABLE 33

Renewable energy capacity factors per technology and per country

Country	PV	Wind: onshore	Wind: offshore
Austria	14.9%	29.7%	
Belgium	13.8%	30.6%	49.8%
Bulgaria	17.8%	26.9%	36.1%
Czechia	14.1%	27.6%	
Cyprus	23.8%		25.4%
Germany	13.8%	29.4%	50.8%
Denmark	13.6%	36.3%	52.5%
Estonia	12.7%	28.4%	48.7%
Greece	20.9%	32.5%	42.3%
Spain	19.4%	28.1%	46.4%
Finland	12.4%	33.0%	48.9%
France	16.4%	29.5%	48.2%
Croatia	17.5%	30.5%	28.8%
Hungary	16.7%	26.5%	
Ireland	12.3%	44.7%	55.8%
Italy	18.7%	28.0%	34.0%
Lithuania	13.1%	29.7%	46.7%
Luxembourg	13.6%	30.6%	
Latvia	13.0%	29.4%	48.8%
Malta	23.4%		30.6%
Netherlands	13.7%	32.2%	49.8%
Poland	13.9%	28.3%	48.1%
Portugal	15.8%	28.1%	38.6%
Romania	16.9%	26.4%	38.7%
Sweden	12.5%	34.1%	49.7%
Slovenia	16.1%	26.5%	
Slovakia	15.2%	27.0%	
United Kingdom	12.8%	37.3%	55.6%

B.2. Blue Hydrogen

The greenfield large scale ATR estimate is based on estimates from H-Vision and H21 projects, for a 5 GW unit, while brownfield estimates are based on IEA's Future of Hydrogen (2019) and Gas for Climate (2019).

TABLE 34

Blue hydrogen techno-economic assumptions

Parameter	Greenfield ATR (5 GW)	Brownfield SMR
CAPEX (€/MWh _{H₂})	800,000-1,000,000	375,000-1,175,000 ²³⁵
OPEX (of Annual CAPEX)	3%	3%
Efficiency (LHV)	69%	69%
Capture rate	94%	60-66%
Emissions w/o CCS (t CO ₂ / MWh _{H₂})	0.29	0.29
CO ₂ transport and storage costs (per tonne of CO ₂)	20-50	20-50
Load hours per year	8,000	8,000
Cost of Capital	6%	6%
Lifetime	20	20

²³⁵ Low estimate assumes fully depreciated SMR unit, high estimate assumes that 50% of investment costs have been depreciated

Appendix C.

Hydrogen Transport Infrastructure – Methodology

C.1. Hydrogen Transport by Pipeline

Hydraulic simulations performed by participating TSOs in the previous iteration of the EHB indicated that smaller compressor stations spaced 100 km apart and larger compressor stations spaced 600 km apart result in similar costs per 100 km transported. These simulations also found that compression capacity of 190-330 MWe per 1000 km is sufficient to operate the network between 40 and 80 bar or between 30 and 67 bar in a 48-inch pipeline.

Compressors are assumed to be electrically powered piston compressors. Compressors are modelled as a single large compressor at the beginning of the stretch of pipe to bring the hydrogen to the pipeline's operating pressure and several evenly-spaced smaller compressor stations to maintain pressure and flow rate along the length of the pipeline. Compressors towards the end of the pipeline are operated at lower capacity or bypassed to allow the pressure to decrease to 30 bar, as this is a suitable pressure delivery pressure for most industrial customers, as determined through stakeholder interviews.

Much of the natural gas transmission infrastructure in Europe consists of pipelines with diameters smaller than 48-inch. To better model this, subsequent hydraulic simulations were performed this year assuming a 48-inch pipeline with a maximum operating pressure of 80 bar, a 36-inch pipeline with a maximum operating pressure of 50 bar, and a 20-inch pipeline with a maximum operating pressure of 50 bar. For each pipeline diameter, necessary compression power was determined to operate the pipeline at 100% capacity, 75% capacity, and 25% capacity. Compressor stations were placed at intervals of 100-200 km. Table 36 includes the outputs of the hydraulic simulations which were used to estimate pipeline costs.

TABLE 35

Network design parameters from hydraulic simulations²²⁶

Parameter	100% Capacity	75% Capacity	25% Capacity
48-inch Pipeline Throughput [GW at LHV (TWh/year)]	16.9 (148)	12.7 (111)	4.2 (37)
36-inch Pipeline Throughput [GW at LHV (TWh/year)]	4.7 (42)	3.6 (32)	1.2 (10)
20-inch Pipeline Throughput [GW at LHV (TWh/year)]	1.2 (10)	0.9 (8)	0.3 (3)
New 48-inch Pipeline CAPEX (€/m)	2,750		
New 36-inch Pipeline CAPEX (€/m)	2,200		
New 20-inch Pipeline CAPEX (€/m)	1,510		
Repurposed 48-inch Pipeline CAPEX (€/m)	500		
Repurposed 36-inch Pipeline CAPEX (€/m)	400		
Repurposed 20-inch Pipeline CAPEX (€/m)	275		
Distance between compressors (km)	100-200		
Input pressure (bar)	30-40		
Output pressure (bar)	30		
Compressor CAPEX (€/MWe)	3,400,000		
48-inch Pipeline Compression Capacity (MWe/1000 km)	434	183	6
36-inch Pipeline Compression Capacity (MWe/1000 km)	93	40	2
20-inch Pipeline Compression Capacity (MWe/1000 km)	26	6	0.6
Electricity cost (€/MWh)	50		
Assumed load factor for compressor electricity consumption (hours/year)	5000		
Compressor type	Electric reciprocating compressor		

The cost of a pipeline can be broken down into three main categories: CAPEX, variable OPEX, and fixed OPEX. CAPEX is comprised of the cost to build a new hydrogen pipeline, build compressor stations, and repurpose existing natural gas pipelines for hydrogen. Variable OPEX consists of the electricity costs to power the compressors. Fixed OPEX is the operating and maintenance costs of the pipeline itself and the compressor stations. The length of the pipeline impacts all three categories of costs. Throughput on the other hand impacts only the variable OPEX. It is possible that lower throughputs would also translate to lower operating and maintenance costs, however this has not been studied. Figure 41 breaks down the cost components of a hydrogen pipeline.

236 Figures provided by Transmission System Operators

FIGURE 41

Summary of pipeline cost components

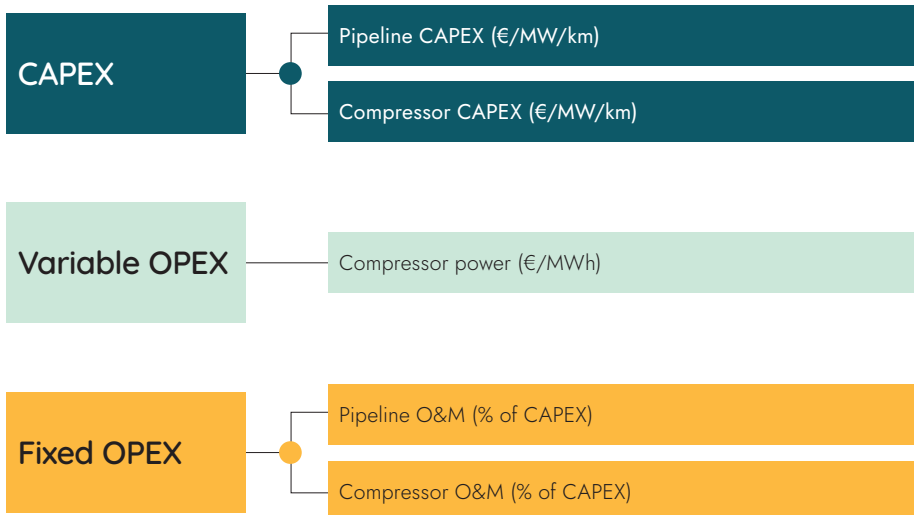

C.2. Hydrogen Transport by Ship

Three ways of shipping were analysed: liquid hydrogen, ammonia, and liquid organic hydrogen carriers (LOHC), specifically toluene.

To model the shipping process, we broke it into 7 steps:

1. **Pipeline from production to export terminal:** Unless the renewable generation and electrolyser are located directly at the port, a pipeline will be required to transport the hydrogen from its point of production to the port.
2. **Liquefaction/conversion:** A facility is required to liquefy the hydrogen, convert it to ammonia (Haber-Bosch process), or convert toluene to cyclohexane.
3. **Storage at export terminal:** Storage is needed to store the liquefied/converted hydrogen before ships arrive at the port, and so that ships can be loaded quickly.
4. **Shipping:** The liquefied/converted hydrogen is transported from the export terminal to the import terminal via tanker ship.
5. **Storage at import terminal:** The liquefied/converted hydrogen is stored at the import terminal to allow for a consistent pipeline flow. It is stored in its liquid/converted state because its energy density is much lower in gaseous state, and it is more difficult to store.
6. **Gasification/reconversion:** A facility is required to gasify the liquid hydrogen, crack the ammonia, or dehydrogenate the cyclohexane to toluene and hydrogen.
7. **Pipeline from export terminal to final destination:** The gaseous hydrogen is delivered by pipeline from the export terminal to its intended destination.

Pipeline sections as part of shipping routes are modelled the same way as all-pipeline routes, assuming a new, 48-inch pipeline.

Overproduction is necessary to overcome losses in shipping and deliver a specific flow to the site of demand. Overproduction is calculated as the larger of boil-off or fuel requirement for ammonia and liquid hydrogen shipping. LOHC dehydrogenation is not 100% efficient, so for LOHC shipping, overproduction is calculated to compensate for hydrogen that is lost in this step. All infrastructure upstream of the shipping portion (including shipping) is sized to account for the overproduction necessary to compensate for shipping losses.

All ships have 160,000 m³ capacity. The number of ships required is determined by calculating the duration of one round trip and what quantity of hydrogen would have to be shipped to meet the specified demand over the course of one round trip. This quantity is then divided by the hydrogen capacity of one ship and rounded up.

Because it is more economically efficient than truck or rail, all ground transport of hydrogen is assumed to be by pipeline in gaseous form, and all conversion and reconversion occurs at the export and import terminals respectively.

Storage is sized to match the amount of hydrogen delivered between ships plus a buffer of 50% to account for variation in the shipping schedule. Storage tanks store hydrogen in the same form as what is shipped, because storing hydrogen in gaseous form would have significantly lower energy density and require compression.

TABLE 36

Key shipping parameters^{237, 238}

Parameter	Liquid Hydrogen	Ammonia	LOHC
Pipeline diameter (in)	48		
Pipeline pressure (bar)	80		
Pipeline condition (new vs. repurposed)	New		
Conversion CAPEX (€/kW H ₂)	1350	808	84
Conversion variable OPEX (kWh/kWh H ₂)	0.3	0.14	0.051
Conversion fixed OPEX (% of CAPEX)	2.5%		
Toluene CAPEX (€/kg tol.) ²³⁹	N/A	N/A	0.30
Ship volume (m ³)	160,000		
Ship speed (knots)	20		
Ship CAPEX (€/ship)	179,944,000	134,924,800	99,600,000
Ship variable OPEX (€/ship/year)	9,900,000	9,047,000	15,604,000
Ship fixed OPEX (% of CAPEX)	4%		
Fuel requirement (MWh/kg/1000 km)	4.0		
Boil-off Rate (%/km)	0.001%	0.00003%	0%
Storage capacity (% of amount of hydrogen delivered between ship loads)	150%		
Storage CAPEX (€/MWh H ₂)	750	226	239
Storage fixed OPEX (% of CAPEX)	2%		
Reconversion efficiency	100%	100%	90%
Reconversion CAPEX (€/kW H ₂)	273	235	237
Reconversion variable OPEX (kWh/kWh H ₂)	0.003	0.14	0.39
Reconversion fixed OPEX	2.5%		
Toluene degradation (%/cycle) ²³⁹	N/A	N/A	0.1%
Electricity cost (€/MWh)	50		

237 Cost estimates pertaining to conversion, reconversion, and storage came from: DNV GL – Study on the Import of Liquid Renewable Energy: Technology Cost Assessment

238 Cost estimates pertaining to shipping came from: <https://www.sciencedirect.com/science/article/pii/S2352484720312312>

239 <https://www.sciencedirect.com/science/article/pii/S0360319920332134>

As with pipelines, shipping costs are divided into CAPEX, variable OPEX, and fixed OPEX. Figure 42 breaks down the cost components associated with shipping.

FIGURE 42

Shipping cost breakdown

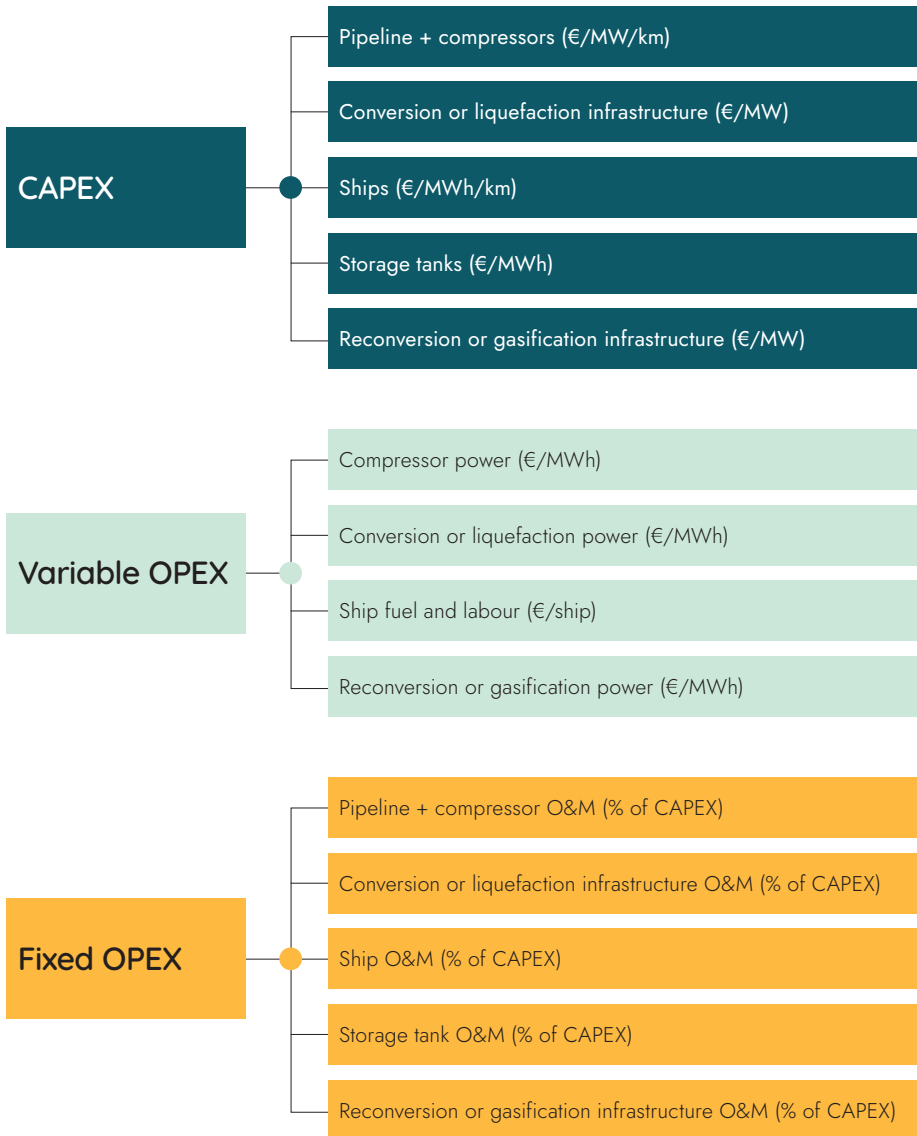

C.3. Comparison of Hydrogen Transport Methods and Supply Routes

The routes and corresponding distances shown in Figure 35 are illustrative and estimations. No analysis was performed to determine the optimal route from an economic, geographical, and/or geopolitical perspective.

C.4. Comparison of Electricity and Hydrogen Infrastructure

To model electricity infrastructure, a straight-line network with no branching or off-takers was assumed, as in the pipeline modelling. The cost of electricity infrastructure is broken down into Wires CAPEX, Converter CAPEX, operating and maintenance, and losses. To model the cost of losses, the total annual losses were multiplied by the assumed electricity cost. Figure 43 breaks down the cost components of electricity infrastructure.

Table 37 includes the assumptions used to estimate the cost of electricity infrastructure.

FIGURE 43

Electricity infrastructure cost breakdown

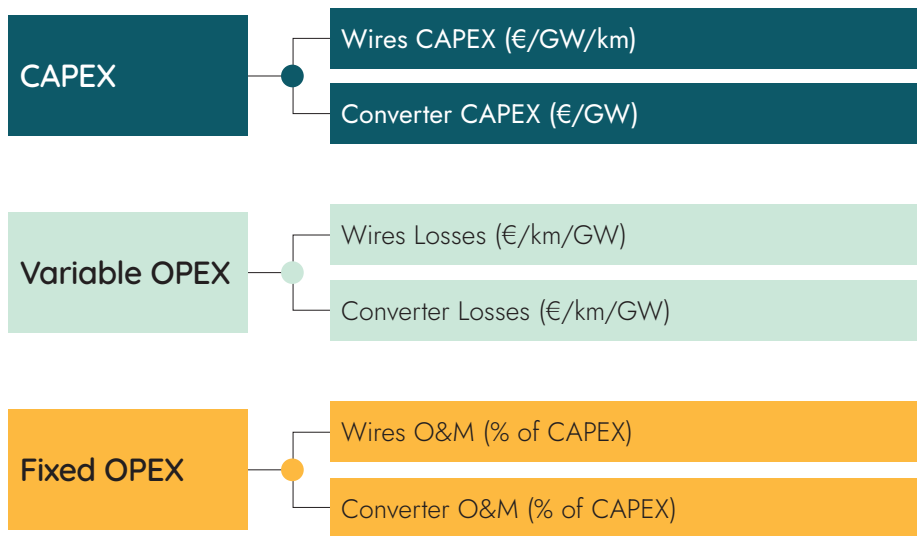

TABLE 37

Assumptions for electricity infrastructure

Parameter	Overhead HVAC	Overhead HVDC	Underground HVDC
Voltage (kV)	380	800	525
Power Rating (MW/MVA)	2800	8000	2000
Losses (% of energy transported/100 km)	1.1%	0.15%	0.5%
CAPEX (k€/km/GW)	190	255	1585
Fixed OPEX (% of CAPEX)		0.2%	
Electricity cost (€/MWh)		50	
Number of Converters	0	2	2
Converter station CAPEX (k€/MW)	N/A		124
Converter station fixed OPEX (% of CAPEX)	N/A		2%
Converter Station losses (% of MWh converted)	N/A		1%
Electricity cost (€/MWh)		50	
Electrolyser efficiency		70%	

To model hydrogen as an end-use, the electricity infrastructure cost was divided by the electrolyser efficiency to account for the additional capacity required to overcompensate for the electrolyser losses at the end of the line. Hydrogen infrastructure was not modified because the electrolyser losses occur before the pipeline.

To model electricity as an end-use, electricity infrastructure cost is not modified but hydrogen infrastructure costs are divided by the square of the electrolyser efficiency to account for the electrolyser losses at the beginning of the pipeline and the fuel cell losses at the end of the pipeline.